



传动行星减速电机

TRANSMISSION PLANETARY

中大力德 实现自动化应用的无限可能

电机驱动 微特电机 精密减速器



▲ 总公司 宁波中大力德智能传动股份有限公司



▲ 子公司 宁波中大创远精密设备有限公司



▲ 子公司 佛山中大力德驱动科技有限公司

宁波中大力德智能传动股份有限公司始创于1998年，是一家集电机驱动、微特电机、精密减速器、机器人结构本体及一体化智能执行单元的研发、制造、销售、服务于一体的国家高新技术企业。公司注册资本15117万元，分、子公司9家，员工1800余人，2017年8月在深交所主板上市，股票代码：002896。

公司系国家级高新技术企业，主导和参与起草国家标准12项，行业标准5项；授权专利107项，其中发明专利14项。拥有机械工业精密齿轮减速电机工程研究中心、浙江省级高新技术企业研究开发中心、浙江省级企业技术中心。

公司立足于智能化、自动化装备核心零部件设计和制造，为客户提供智能驱动解决方案。公司产品以其差异化和高性价比优势，广泛应用于工作母机、数控设备、工业机器人、智能物流、新能源、食品、包装、纺织、电子、医疗、通讯、农牧等机械装备领域。在替代进口产品的基础上，逐步参与国际竞争。

Ningbo Zhongda Leader Intelligent Transmission Co., Ltd. was founded in 1998. It is an electromechanical automation enterprise integrating R&D, manufacturing, sales and service of motor drives, micro motors, precision reducers and integrated products. It has 9 branches and subsidiaries, over 1,800 employees, and a registered capital of 151.17 million yuan. In August 2017, it was listed on the A-shares of the Shenzhen Stock Exchange (stock code 002896).

The company is a national-level high-tech enterprise, leading and participating in the drafting of 10 national standards and 5 industry standards, maintaining 107 patents and 11 invention patents. It's owning a Zhejiang-level enterprise R&D center.

The company is based on intelligent and automation equipment core component manufacturers and design solution providers. With its differentiated and cost-effective advantages, the company's products are widely used in industrial robots, intelligent logistics, new energy, machine tools and other fields, as well as special machinery and equipment for food, packaging, textiles, electronics, and medical treatment. On the basis of realizing domestic substitution of imported products, gradually participate in international competition.

传动型行星 PLANETARY GEAR MOTOR

- 采用双支撑结构输出轴，使齿轮箱的承载扭力大大提高。

Adopt dual supporting structure for output shaft so that the max torque of gearbox is increased a lot.

- 太阳轮与行星架采用花键联接方式，极大增强了内部齿轮箱承受扭矩，提高了整机的使用寿命。

Sun wheel and planetary wheel are connected by spline which increase the max torque of gearbox and lengthen the life.

- 与电机连接的输入级采用斜齿，在高转速状态下，使齿轮箱的传动更加平稳，噪音更低。
- 齿轮箱内齿轮部分采用分段式结构，是齿轮箱的速比分布更广，整机结构设计更灵活。
- 齿轮箱与电机连接采用止口定位，轴向锁紧螺丝，使整机配合更精密，噪音更低。

• We use helical gear at input stage which make the noise low and run smoothly in high speed. • The inner gear ring is separated so that we can make more ratio and the design is flexible. • Gearbox and motor are located by a seam fix by screw in axial which increase the matching precision and reduce noise.

- 行星轮内孔采用滚针保持架，用滚动摩擦代替滑动摩擦，使齿轮箱的寿命更加长。

We use rolling pin holder inside planetary wheel. we use rolling friction instead of sliding grinding so the life of gearbox is much longer.

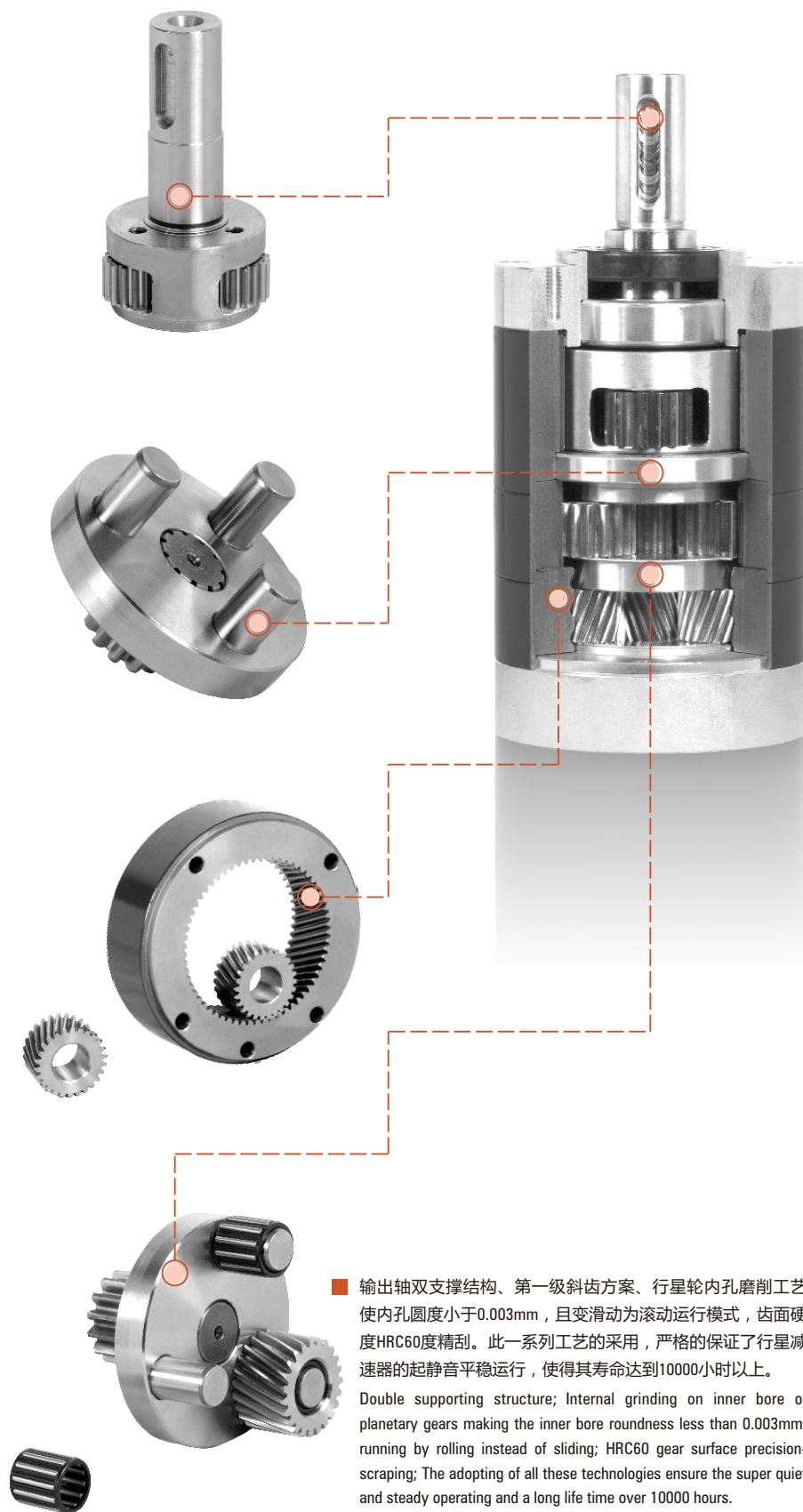

- 输出轴双支撑结构、第一级斜齿方案、行星轮内孔磨削工艺使内孔圆度小于0.003mm，且变滑动为滚动运行模式，齿面硬度HRC60度精刮。此一系列工艺的采用，严格的保证了行星减速器的起静音平稳运行，使得其寿命达到10000小时以上。

Double supporting structure; Internal grinding on inner bore of planetary gears making the inner bore roundness less than 0.003mm; running by rolling instead of sliding; HRC60 gear surface precision-scraping; The adopting of all these technologies ensure the super quiet and steady operating and a long life time over 10000 hours.

品名阅读方法 TYPE AND MOTOR NUMBER

电动机 Motor

Z 62 BLDPN 24 60 - 30S
 ① ② ③ ④ ⑤ ⑥

电机参数 Motor Parameters	①	宁波中大德智能传动股份有限公司标识 ZD Logo
	②	电机外形尺寸 Motor Outline Dimension: 22:电机外径 Outer diameter Φ22mm 32:电机外径 Outer diameter Φ32mm 42:电机外径 Outer diameter Φ42mm 52:电机外径 Outer diameter Φ52mm 62:电机外径 Outer diameter Φ62mm 72:电机外径 Outer diameter Φ72mm 82:电机外径 Outer diameter Φ82mm 105:电机外径 Outer diameter Φ105mm 120:电机外径 Outer diameter Φ120mm
	③	电机型式 Motor Type: BLDPN:无刷直流电机, 配行星减速箱式 BLDC motor, matched with planetary gearbox DPN:有刷直流电机, 配行星减速箱式 Brush DC motor, matched with planetary gearbox
	④	电机使用额定电压 Rated Voltage For The Motor Using 12:12V 24:24V
	⑤	电机输出额定功率 Rated Output Power For The Motor 40:40W 60:60W
	⑥	电机输出额定转速 Rated Output Speed For The Motor 20S:2000RPM 30S:3000RPM

减速机 Reducer

62 ZPN 303
 ① ② ③

①	减速机外形尺寸 Motor Outline Dimension: 22:减速机外径 Gear box external diameter Φ22mm 32:减速机外径 Gear box external diameter Φ32mm 42:减速机外径 Gear box external diameter Φ42mm 52:减速机外径 Gear box external diameter Φ52mm 62:减速机外径 Gear box external diameter Φ62mm 72:减速机外径 Gear box external diameter Φ72mm 82:减速机外径 Gear box external diameter Φ82mm 105:减速机外径 Gear box external diameter Φ105mm 120:减速机外径 Gear box external diameter Φ120mm
②	类型 Motor Outline Dimension: ZPN:减速器输入斜齿轮 Gear box input shaft is helical gear
③	减速比 Gear Ratio: 例.303:减速比 Reduction ratio:303:1

■ ZPNΦ32 BRUSH有刷



■ 外径32直流有刷行星减速电机外形图纸 Outside Diameter 32 DC Brush Motor

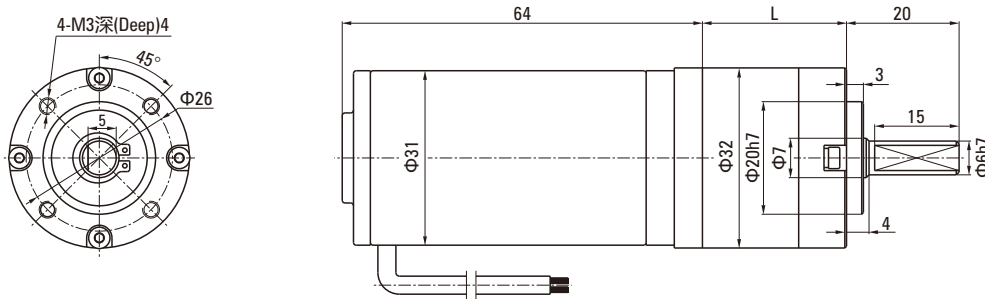

电机型号 Motor Type	减速箱型号 Gearbox Model	减速比 Gear Ratio	L尺寸(mm) Dimension
Z32DPN	32ZPN□	一级Stage1	3.7~6.75
		二级Stage2	14~46
		三级Stage3	51~308

电机接线图 Wiring Diagram

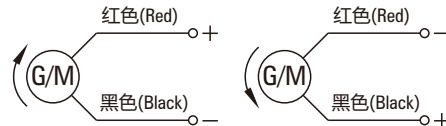

■ 有刷直流电机技术参数 Blush DC Motor Technical Data

电机型号 Motor Type	电压 Voltage	功率 Power	空载电流 No-load Current	空载转速 No-load Speed	额定电流 Rated Current	额定转速 Rated Speed	额定力矩 Rated Torque	电机寿命 Motor Life
	V	W	A	RPM	A	RPM	N.m	H
Z32DPN2410-40S	24	10	0.4	5000	0.7	4000	0.024	2000
Z32DPN2415-50S	24	15	0.5	6000	1.1	5000	0.029	2000

■ 有刷直流行星减速电机技术参数 Blush DC Planetary Gear Motor Technical Data-Z32DPN2410-40S

减速比 Ratio	3.7	4.29	5.18	6.75	13.73	19.2	25	28.93	34.97	45.56	50.89	68.08	78.7
输出轴转速 r/min Output shaft speed	1081	932	772	592	285	210	160	137	114	87	78	59	50
允许力矩 N.m Allowable torque	0.080	0.092	0.111	0.145	0.270	0.367	0.483	0.561	0.6777	0.890	0.889	1.185	1.3777
减速级数 Reduction stage	1	1	1	1	2	2	2	2	2	2	3	3	3
减速比 Ratio	92.7	99.5	115.1	129.6	149.9	168.85	195.28	236.1	307.54				
输出轴转速 r/min Output shaft speed	43	40	35	31	26	23	20	17	13				
允许力矩 N.m Allowable torque	1.621	1.743	2.004	2.266	2.614	2.945	3.400	4.000	4.000				
减速级数 Reduction stage	3	3	3	3	3	3	3	3	3				

ZPN系列 ZPN SERIES

■ ZPNΦ32 BRUSHLESS无刷

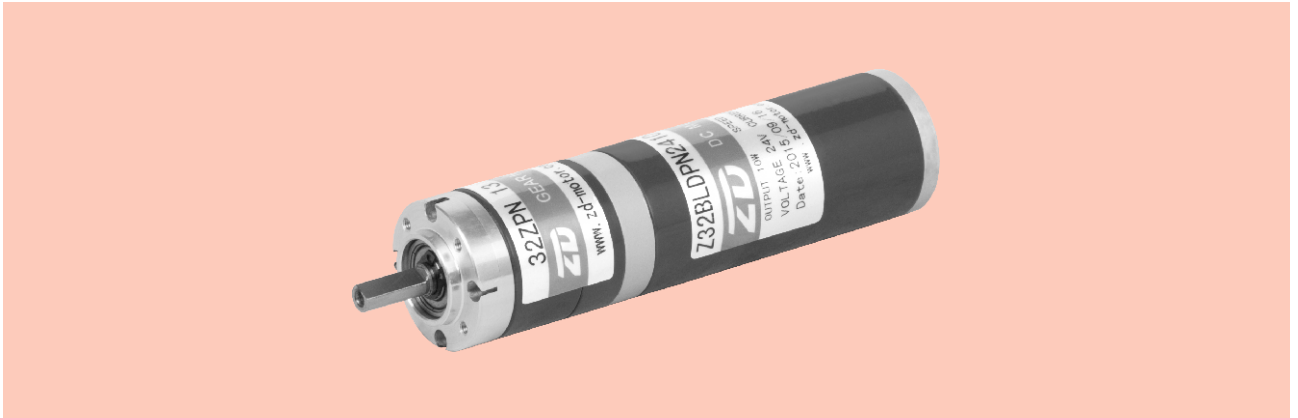

■ 外径32直流无刷行星减速电机外形图纸 Outside Diameter 32 DC Brushless Motor

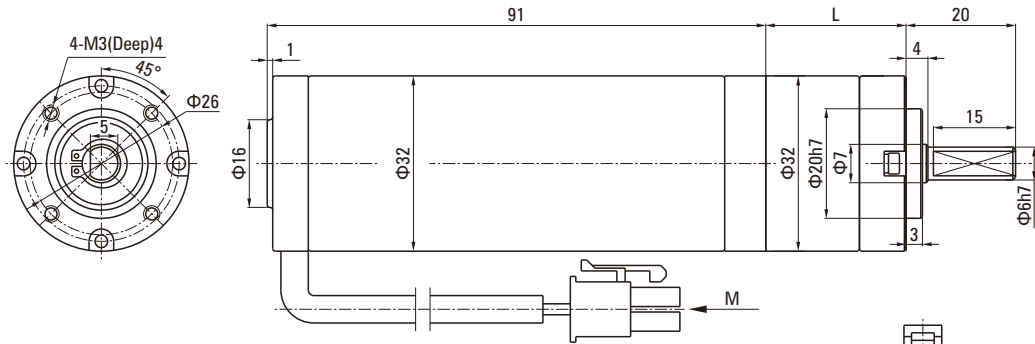

电机型号 Motor Type	减速箱型号 Gearbox Model	减速比 Gear Ratio	L尺寸(mm) Dimension
Z32BLDPN	32PN□	3.7~6.75	25.6
		13.73~45.56	35.9
		50.89~307.54	46.2

M向视图
(View M)

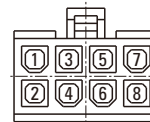

1	2	3	4	5	6	7	8
U	V	W	GND	Hv	Hw	Hu	+Vcc

■ 无刷直流电机技术参数 BLDC Motor Technical Data

电机型号 Motor Type	电压 Voltage V	额定功率 Rated Power W	额定电流 Rated Current A	额定转速 Rated Speed RPM	额定力矩 Rated Torque N.m	防护等级 Grade Protection IP
Z32BLDPN2420-40S	24	20	1.3	4000	0.048	20

■ 无刷直行星减速电机技术参数 BLDC Planetary Gear Motor Technical Data-Z32BLDPN2420-40S

减速比 Ratio	3.7	4.29	5.18	6.75	13.73	19.2	25	28.93	34.97	45.56	50.89	68.08	78.7
输出轴转速 r/min Output shaft speed	1081	932	772	593	291	208	160	138	114	88	79	59	51
允许力矩 N.m Allowable torque	0.16	0.092	0.22	0.29	0.53	0.74	0.97	1.12	1.35	1.76	1.77	2.37	2.74
减速级数 Reduction stage	1	1	1	1	2	2	2	2	2	2	3	3	3

减速比 Ratio	92.7	99.5	115.1	129.6	149.9	168.85	195.28	236.1	307.54				
输出轴转速 r/min Output shaft speed	43	40	35	31	27	24	20	17	13				
允许力矩 N.m Allowable torque	3.23	3.47	4.00	4.00	4.00	4.00	4.00	4.00	4.00				
减速级数 Reduction stage	3	3	3	3	3	3	3	3	3				

■ ZPNΦ32

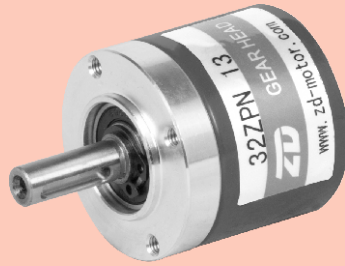

■ 外径32行星减速器 Outdiameter 32mm Planetary Gearbox

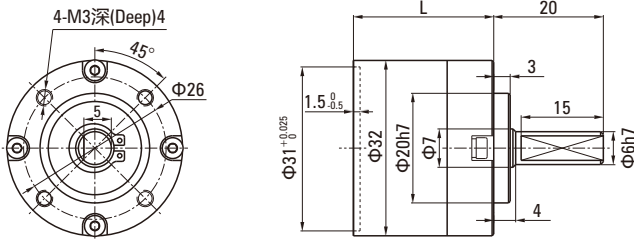

减速箱型号 Gearbox Model	减速比 Gear Ratio	L尺寸(mm) Dimension
32ZPN□	一级Stage1	3.7~6.75
	二级Stage2	14~46
	三级Stage3	51~308

传动级数 Transmission Stage	一级 Stage 1	二级 Stage 2	三级 Stage 3
传动效率 Transmission efficiency	90%	81%	73%
最大径向负载 Max radial load	140N	140N	140N
最大轴向负载 Max axial load	50N	50N	50N
额定扭矩 Rated torque	1N.m	2.25N.m	4N.m
瞬间承受扭矩 Instant beared torque	2倍与额定扭矩 Two times of the rated torque		
工作温度 Operating temperature	-10°C ~ +80°C		
润滑方式 Lubrication type	终生润滑 Lifetime lubrication		
安装方式 Mounting type	任意安装 Any		
推荐输入转速 Recommend input speed	≤3000RPM		
输入与输出转向 Input and output direction	相同 Same direction		
噪音 Noise	< 60dB(A) (L=1m, 3000rpm)		

电机配合方案 Motor Matching Scheme

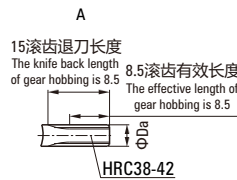
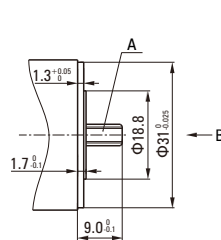
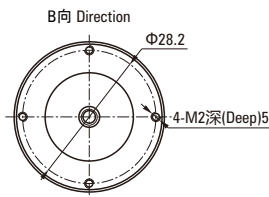

Da	一级速比 One stage of gear ratio	二级速比 Second stage of gear ratio	三级速比 Third stage of gear ratio	
Φ8.02 ^{-0.05/-0.08}	3.7	13.73	50.89	-
Φ7.05 ^{-0.05/-0.08}	4.29	-	68.08	-
		-	78.7	-
Φ5.82 ^{-0.05/-0.08}	5.18	19.2	99.5	-
		-	115.1	-
Φ4.57 ^{-0.05/-0.08}	6.75	25	92.7	168.85
		28.93	129.6	195.28
		34.97	149.9	236.1
		45.56	-	307.54

ZPN系列 ZPN SERIES

■ ZPNΦ42 BRUSH有刷



■ 外径42直流有刷行星减速电机外形图纸 Outside Diameter 42 DC Brush Motor

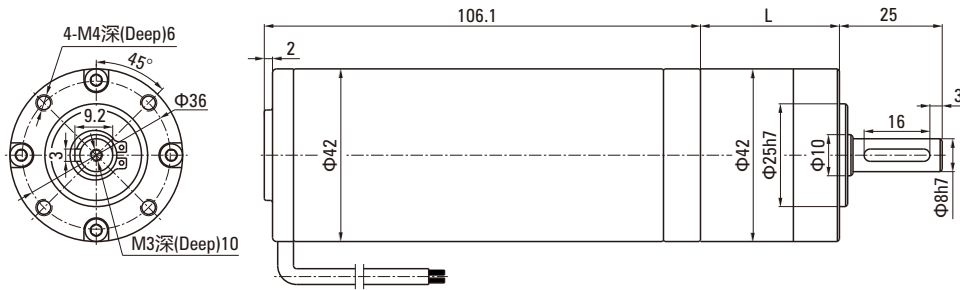

电机型号 Motor Type	减速箱型号 Gearbox Model	减速比 Gear Ratio	L尺寸(mm) Dimension
Z42DPN	42PN□	3.65~8.63	33.8
		13.53~58.22	47.4
		67.08~392.98	61.0

电机接线图 Wiring Diagram

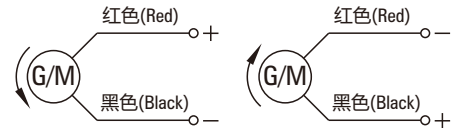

■ 有刷直流电机技术参数 Blush DC Motor Technical Data

电机型号 Motor Type	电压 Voltage V	额定功率 Rated Power W	空载电流 No-load Current A	空载转速 No-load Speed RPM	额定电流 Rated Current A	额定转速 Rated Speed RPM	额定力矩 Rated Torque N.m	电机寿命 Motor Life H
Z42DPN2425-30S	24	25	0.6	3500	1.6	3000	0.080	600

■ 有刷直流行星减速电机技术参数 Blush DC Planetary Gear Motor Technical Data-Z42DPN2425-30S

减速比 Ratio	3.65	5.36	6.55	8.63	13.53	18.92	24.65	28.05	33.92	44.69	58.22	67.08	81.11
输出轴转速 r/min Output shaft speed	822	560	458	348	222	159	122	107	89	67	52	45	37
允许力矩 N.m Allowable torque	0.26	0.39	0.47	0.62	0.88	1.23	1.60	1.82	2.20	2.90	3.77	2.75	4.74
减速级数 Reduction stage	1	1	1	1	2	2	2	2	2	2	2	3	3

减速比 Ratio	91.36	102.88	118.98	127.74	145.36	165.64	191.56	231.61	301.68	392.98			
输出轴转速 r/min Output shaft speed	33	29	25	24	21	18	16	13	9.9	7.6			
允许力矩 N.m Allowable torque	5.34	6.01	6.95	7.46	8.49	9.67	11.19	13.53	15.00	15.00			
减速级数 Reduction stage	3	3	3	3	3	3	3	3	3	3			

■ ZPNΦ42 BRUSHLESS无刷

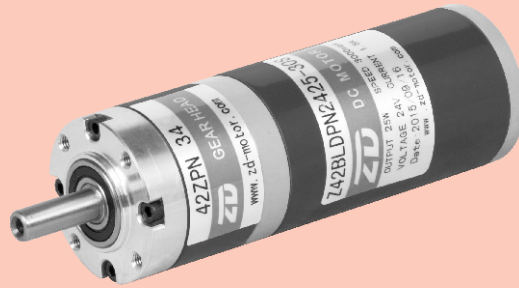

■ 外径42直流无刷行星减速电机外形图纸 Outside Diameter 42 DC Brushless Motor

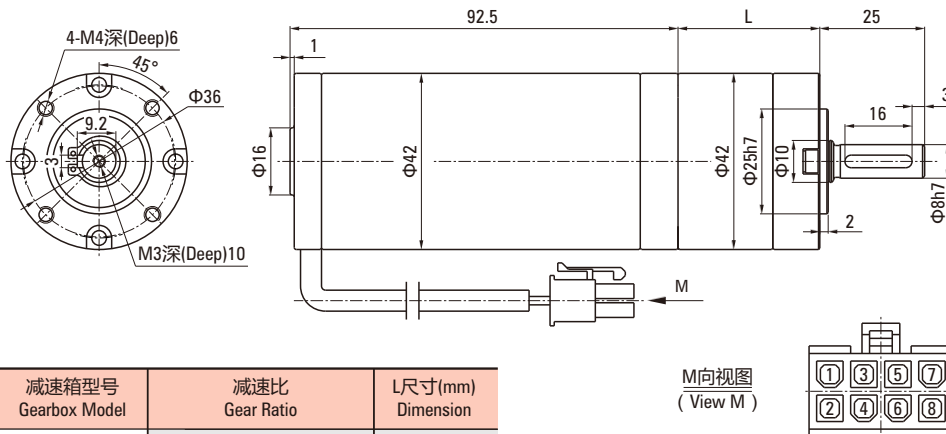

电机型号 Motor Type	减速箱型号 Gearbox Model	减速比 Gear Ratio	L尺寸(mm) Dimension
Z42BLDPN	42PN□	3.65~8.63	33.8
		13.53~58.22	47.4
		67.08~392.98	61.0

1	2	3	4	5	6	7	8
U	V	W	GND	Hv	Hw	Hu	+Vcc

■ 无刷直流电机技术参数 BLDC Motor Technical Data

电机型号 Motor Type	电压 Voltage V	额定功率 Rated Power W	额定电流 Rated Current A	额定转速 Rated Speed RPM	额定力矩 Rated Torque N.m	防护等级 Grade Protection IP
Z42BLDPN2440-30S	24	40	2.4	3000	0.127	20

■ 无刷直流行星减速电机技术参数 BLDC Planetary Gear Motor Technical Data-Z42BLDPN2440-30S

减速比 Ratio	3.65	5.36	6.55	8.63	13.53	18.92	24.65	28.05	33.92	44.69	58.22	67.08	81.11
输出轴转速 r/min Output shaft speed	822	560	458	348	222	159	122	107	88	67	52	45	37
允许力矩 N.m Allowable torque	0.42	0.61	0.75	0.99	1.40	1.95	2.54	2.89	3.50	4.61	6.00	6.24	7.54
减速级数 Reduction stage	1	1	1	1	2	2	2	2	2	2	2	3	3
减速比 Ratio	91.36	102.88	118.98	127.74	145.36	165.64	191.56	231.61	301.68	392.98			
输出轴转速 r/min Output shaft speed	33	29	25	23	21	18	16	13	10	8			
允许力矩 N.m Allowable torque	8.49	9.55	11.06	11.87	13.51	15.0	15.0	15.0	15.0	15.0			
减速级数 Reduction stage	3	3	3	3	3	3	3	3	3	3			

ZPN系列 ZPN SERIES

■ ZPNΦ42

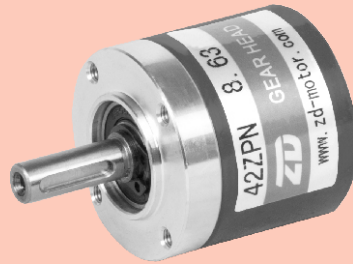

■ 外径42行星减速器 Outdiameter 42mm Planetary Gearbox

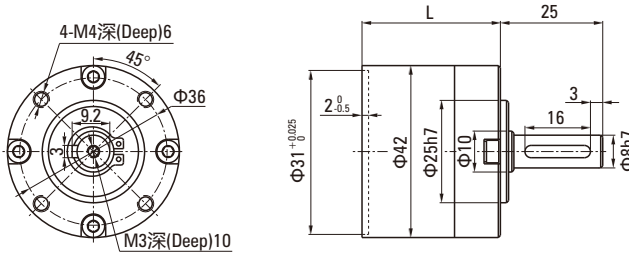

减速箱型号 Gearbox Model	减速比 Gear Ratio	L尺寸(mm) Dimension
42ZPN□	一级Stage1	3.65~8.63
	二级Stage2	14~58
	三级Stage3	67~393

传动级数 Transmission Stage	一级 Stage 1	二级 Stage 2	三级 Stage 3
传动效率 Transmission efficiency	90%	81%	73%
最大径向负载 Max radial load	300N	300N	300N
最大轴向负载 Max axial load	110N	110N	110N
额定扭矩 Rated torque	3N.m	7.5N.m	15N.m
瞬间承受扭矩 Instant beared torque	2倍与额定扭矩 Two times of the rated torque		
工作温度 Operating temperature	-10°C ~ +80°C		
润滑方式 Lubrication type	终生润滑 Lifetime lubrication		
安装方式 Mounting type	任意安装 Any		
推荐输入转速 Recommend input speed	≤3000RPM		
输入与输出转向 Input and output direction	相同 Same direction		
噪音 Noise	< 60dB(A) (L=1m, 3000rpm)		

电机配合方案 Motor Matching Scheme

Da	一级速比 One stage of gear ratio	二级速比 Second stage of gear ratio	三级速比 Third stage of gear ratio
Φ7.12 ^{-0.05/-0.08}	5.36	-	102.88
		-	118.98
Φ5.78 ^{-0.05/-0.08}	6.55	28.05	145.36
		33.92	-
Φ4.56 ^{-0.05/-0.08}	8.63	44.69	165.64
		58.22	191.56
		-	231.61
		-	301.68
		-	392.98
Φ10.73 ^{-0.05/-0.08}	3.65	13.53	67.08
		18.92	81.11
		24.65	91.36
		-	127.74

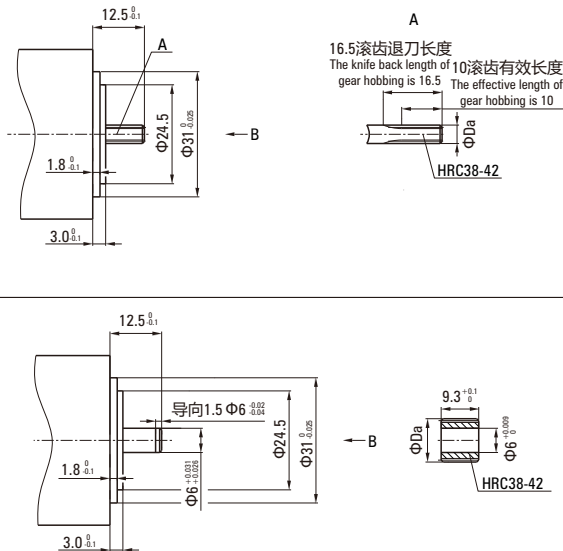
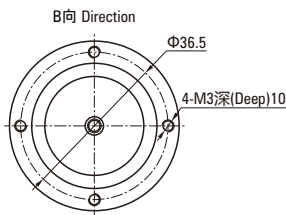

■ ZPNΦ52 BRUSH有刷



■ 外径52直流有刷行星减速电机外形图纸 Outside Diameter 52 DC Brush Motor

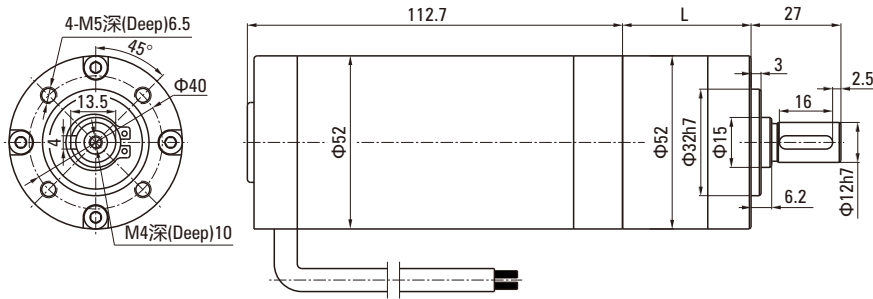

电机型号 Motor Type	减速箱型号 Gearbox Model	减速比 Gear Ratio	L尺寸(mm) Dimension
Z52DPN	52PN□	3.65~8.63	38.6
		13.53~58.22	54.2
		67.08~392.98	69.8

电机接线图 Wiring Diagram

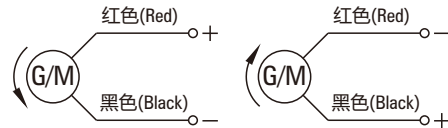

■ 有刷直流电机技术参数 BLDC Motor Technical Data

电机型号 Motor Type	电压 Voltage V	额定功率 Rated Power W	空载电流 No-load Current A	空载转速 No-load Speed RPM	额定电流 Rated Current A	额定转速 Rated Speed RPM	额定力矩 Rated Torque N.m	电机寿命 Motor Life H
Z52DPN2440-30S	24	40	1.0	3500	2.5	3000	0.127	2000
Z52DPN2460-30S	24	60	1.2	3600	4.0	3000	0.191	2000

■ 有刷直行星减速电机技术参数 Blush DC Planetary Gear Motor Technical Data-Z52DPN2440-30S

减速比 Ratio	3.65	5.36	6.55	8.63	13.53	18.92	24.65	28.05	33.92	44.69	58.22	67.08	81.11
输出轴转速 r/min Output shaft speed	822	560	458	348	222	159	122	107	89	67	52	45	37
允许力矩 N.m Allowable torque	0.42	0.61	0.75	0.99	1.39	1.95	2.54	2.89	3.49	4.60	5.99	6.22	7.52
减速级数 Reduction stage	1	1	1	1	2	2	2	2	2	2	2	3	3

减速比 Ratio	91.36	102.88	118.98	127.74	145.36	165.64	191.56	231.61	301.68	392.98			
输出轴转速 r/min Output shaft speed	33	29	25	24	21	18	16	13	9.9	7.6			
允许力矩 N.m Allowable torque	8.47	9.54	11.03	11.84	13.48	15.36	17.76	21.47	25.00	25.00			
减速级数 Reduction stage	3	3	3	3	3	3	3	3	3	3			

ZPN系列 ZPN SERIES

■ ZPNΦ52 BRUSHLESS无刷

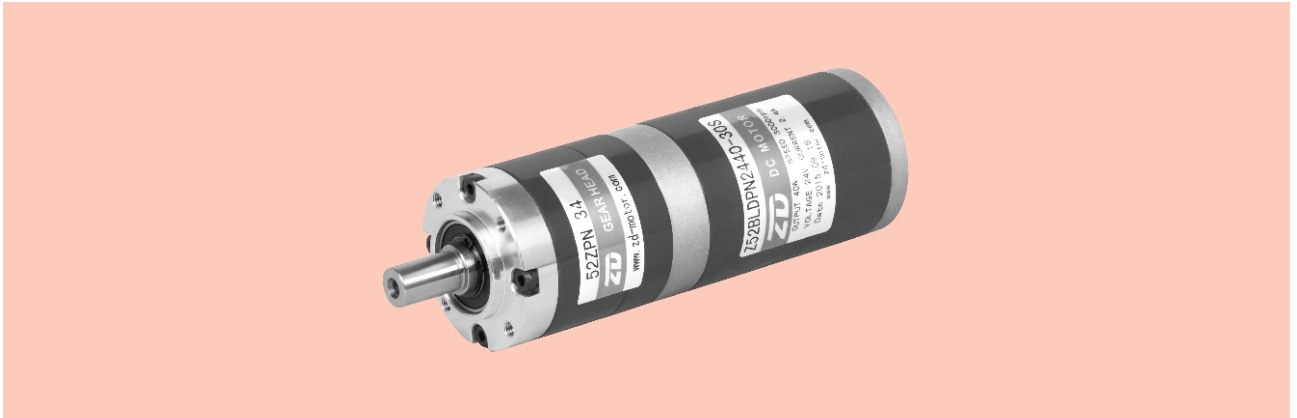

■ 外径52直流无刷行星减速电机外形图纸 Outside Diameter 52 DC Brushless Motor

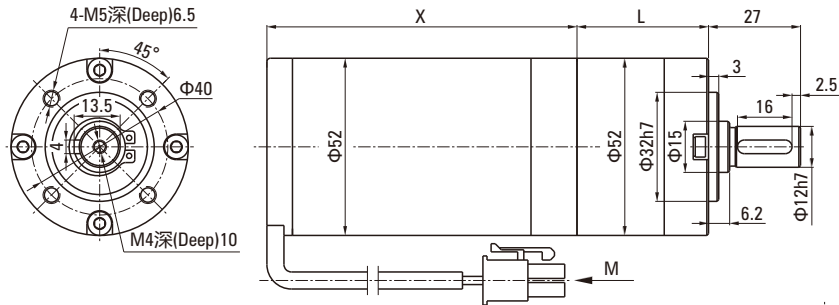

M向视图
(View M)

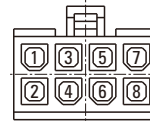

1	2	3	4	5	6	7	8
U	V	W	GND	Hv	Hw	Hu	+Vcc

电机型号 Motor Type	X尺寸 (mm) Dimension	减速箱型号 Gearbox Model	减速比 Gear Ratio	L尺寸 (mm) Dimension
Z52BLDPN2440-30S	91	52PN□	3.65~8.63	38.6
Z52BLDPN2460-30S	110		13.53~58.22	54.2
			67.08~392.98	69.8

■ 无刷直流电机技术参数 BLDC Motor Technical Data

电机型号 Motor Type	电压 Voltage V	额定功率 Rated Power W	额定电流 Rated Current A	额定转速 Rated Speed RPM	额定力矩 Rated Torque N.m	防护等级 Grade Protection IP
Z52BLDPN2440-30S	24	40	2.4	3000	0.127	20
Z52BLDPN2460-30S	24	60	3.8	3000	0.191	20

■ 无刷直流行星减速电机技术参数 BLDC Planetary Gear Motor Technical Data-Z52BLDPN2440-30S

减速比 Ratio	3.65	5.36	6.55	8.63	13.53	18.92	24.65	28.05	33.92	44.69	58.22	67.08	81.11
输出轴转速 r/min Output shaft speed	822	560	458	348	222	159	122	107	88	67	52	45	37
允许力矩 N.m Allowable torque	0.42	0.61	0.75	0.99	1.40	1.95	2.54	2.89	3.50	4.61	6.00	6.24	7.54
减速级数 Reduction stage	1	1	1	1	2	2	2	2	2	2	2	3	3

减速比 Ratio	91.36	102.88	118.98	127.74	145.36	165.64	191.56	231.61	301.68	392.98			
输出轴转速 r/min Output shaft speed	33	29	25	23	21	18	16	13	10	8			
允许力矩 N.m Allowable torque	8.49	9.55	11.06	11.87	13.51	15.40	17.81	21.53	25	25			
减速级数 Reduction stage	3	3	3	3	3	3	3	3	3	3			

ZPNΦ52

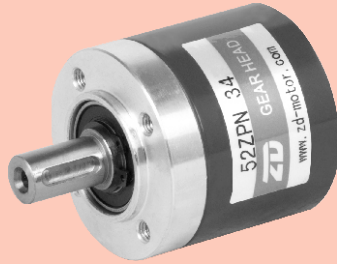

■ 外径52行星减速器 Outdiameter 52mm Planetary Gearbox

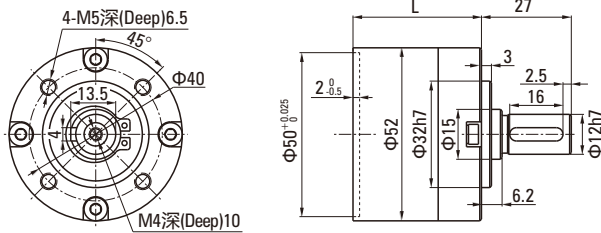

减速箱型号 Gearbox Model	减速比 Gear Ratio	L尺寸(mm) Dimension
52ZPN□	一级Stage1	3.65~8.63
	二级Stage2	14~58
	三级Stage3	67~393

传动级数 Transmission Stage	一级 Stage 1	二级 Stage 2	三级 Stage 3
传动效率 Transmission efficiency	90%	81%	73%
最大径向负载 Max radial load	450N	450N	450N
最大轴向负载 Max axial load	150N	150N	150N
额定扭矩 Rated torque	4N.m	12N.m	25N.m
瞬间承受扭矩 Instant beared torque	2倍与额定扭矩 Two times of the rated torque		
工作温度 Operating temperature	-10°C ~ +80°C		
润滑方式 Lubrication type	终生润滑 Lifetime lubrication		
安装方式 Mounting type	任意安装 Any		
推荐输入转速 Recommend input speed	≤3000RPM		
输入与输出转向 Input and output direction	相同 Same direction		
噪音 Noise	< 60dB(A) (L=1m, 3000rpm)		

电机配合方案 Motor Matching Scheme

	Da	一级速比 One stage of gear ratio	二级速比 Second stage of gear ratio	三级速比 Third stage of gear ratio
	Φ8.88 ^{+0.05} _{-0.08}	5.36	-	102.88
	Φ7.23 ^{+0.05} _{-0.08}	6.55	28.05	145.36
	Φ5.73 ^{+0.05} _{-0.08}	8.63	44.69	165.64
			58.22	191.56
			-	231.61
			-	301.68
			-	392.98
	Φ13.42 ^{+0.05} _{-0.08}	3.65	13.53	67.08
			18.92	81.11
			24.65	91.36
			-	127.74

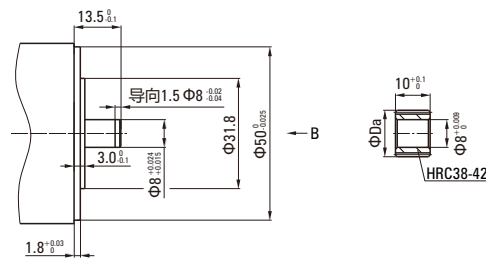
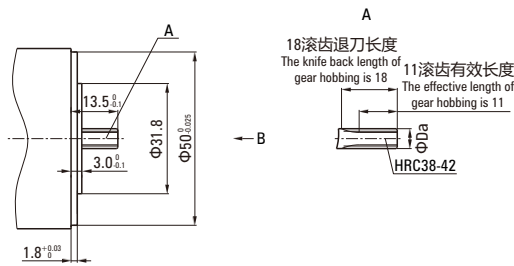
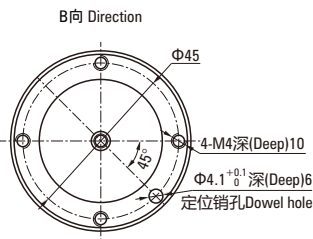

ZPN系列 ZPN SERIES

■ ZPNΦ62 BRUSH有刷

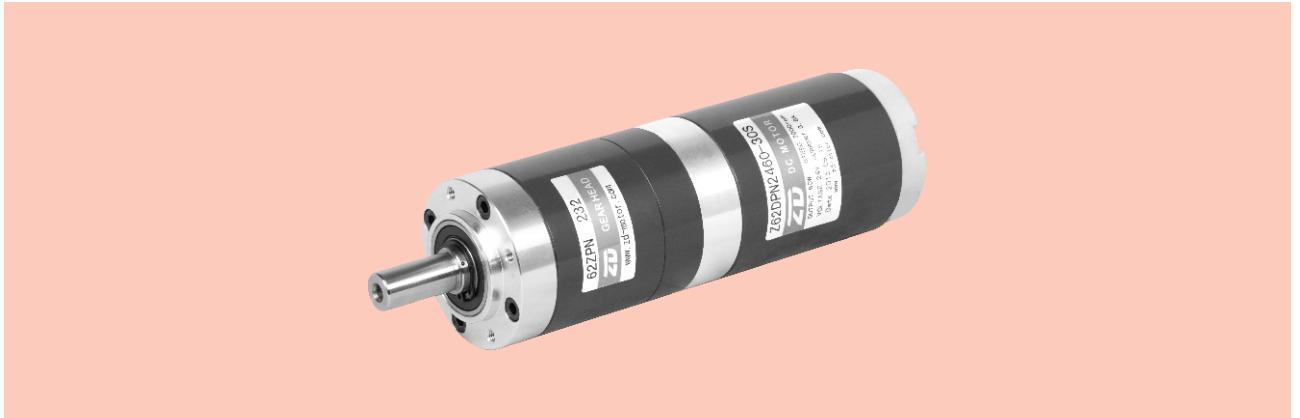

■ 外径62直流有刷行星减速电机外形图纸 Outside Diameter 62 DC Brush Motor

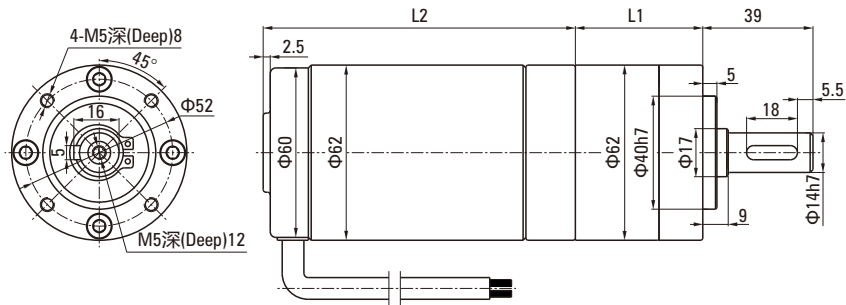

电机型号 Motor Type	减速箱型号 Gearbox Model	减速比 Gear Ratio	L尺寸(mm) Dimension
Z62DPN	62PN□	3.65~8.63	45.1
		13.53~58.22	62.7
		67.08~392.98	80.3

电机接线图 Wiring Diagram

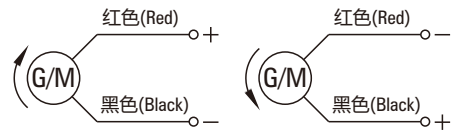

■ 有刷直流电机技术参数 Blush DC Motor Technical Data

电机型号 Motor Type	电压 Voltage V	额定功率 Rated Power W	空载电流 No-load Current A	空载转速 No-load Speed RPM	额定电流 Rated Current A	额定转速 Rated Speed RPM	额定力矩 Rated Torque N.m	电机寿命 Motor Life H	L ₂ 尺寸 Dimension mm
Z62DPN2440-30S	24	40	1.2	3500	2.5	3000	0.127	2000	110.5
Z62DPN2460-30S	24	60	1.2	3500	3.5	3000	0.191	2000	121.5
Z62DPN2490-30S	24	90	1.5	3700	5.5	3000	0.287	2000	133.5

■ 有刷直流行星减速电机技术参数 Blush DC Planetary Gear Motor Technical Data-Z62DPN2460-30S

减速比 Ratio	3.65	5.36	6.55	8.63	13.53	18.92	24.65	28.05	33.92	44.69	58.22	67.08	81.11
输出轴转速 r/min Output shaft speed	822	560	458	348	222	159	122	107	89	67	52	45	37
允许力矩 N.m Allowable torque	0.63	0.92	1.13	1.48	2.09	2.93	3.81	4.34	5.25	6.91	9.01	9.35	11.31
减速级数 Reduction stage	1	1	1	1	2	2	2	2	2	2	2	3	3

减速比 Ratio	91.36	102.88	118.98	127.74	145.36	165.64	191.56	231.61	301.68	392.98			
输出轴转速 r/min Output shaft speed	33	29	25	24	21	18	16	13	9.9	7.6			
允许力矩 N.m Allowable torque	12.74	14.34	16.58	17.81	20.27	23.10	26.71	32.29	42.06	50.00			
减速级数 Reduction stage	3	3	3	3	3	3	3	3	3	3			

■ ZPNΦ62 BRUSHLESS无刷

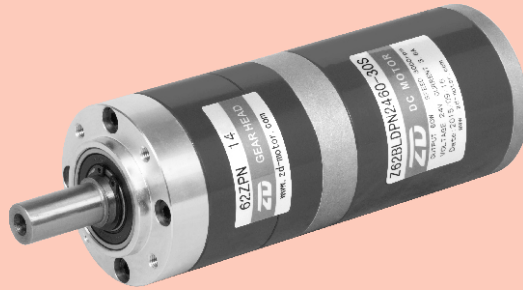

■ 外径62直流无刷行星减速电机外形图纸 Outside Diameter 62 DC Brushless Motor

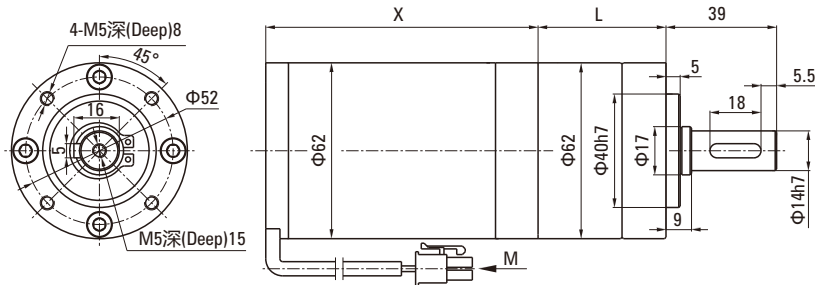

电机型号 Motor Type	X尺寸 (mm) Dimension	减速箱型号 Gearbox Model	减速比 Gear Ratio	L尺寸 (mm) Dimension
Z62BLDPN2460-30S	96	62PN□	3.65~8.63	45.1
Z62BLDPN2490-30S	113		13.53~58.22	62.7
			67.08~392.98	80.3

M向视图
(View M)

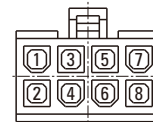

1	2	3	4	5	6	7	8
U	V	W	GND	Hv	Hw	Hu	+Vcc

■ 无刷直流电机技术参数 BLDC Motor Technical Data

电机型号 Motor Type	电压 Voltage V	额定功率 Rated Power W	额定电流 Rated Current A	额定转速 Rated Speed RPM	额定力矩 Rated Torque N.m	防护等级 Grade Protection IP
Z62BLDPN2460-30S	24	60	3.4	3000	0.191	20
Z62BLDPN2490-30S	24	90	5.4	3000	0.287	20

■ 无刷直流行星减速电机技术参数 BLDC Planetary Gear Motor Technical Data-Z62BLDPN2460-30S

减速比 Ratio	3.65	5.36	6.55	8.63	13.53	18.92	24.65	28.05	33.92	44.69	58.22	67.08	81.11
输出轴转速 r/min Output shaft speed	822	560	458	348	222	159	122	107	88	67	52	45	37
允许力矩 N.m Allowable torque	0.63	0.92	1.13	1.48	2.09	2.93	3.81	4.34	5.25	6.91	9.01	9.35	11.31
减速级数 Reduction stage	1	1	1	1	2	2	2	2	2	2	2	3	3
减速比 Ratio	91.36	102.88	118.98	127.74	145.36	165.64	191.56	231.61	301.68	392.98			
输出轴转速 r/min Output shaft speed	33	29	25	23	21	18	16	13	10	8			
允许力矩 N.m Allowable torque	12.74	14.34	16.59	17.81	20.27	23.10	26.71	32.29	42.06	45.00			
减速级数 Reduction stage	3	3	3	3	3	3	3	3	3	3			

ZPN系列 ZPN SERIES

■ ZPNΦ62

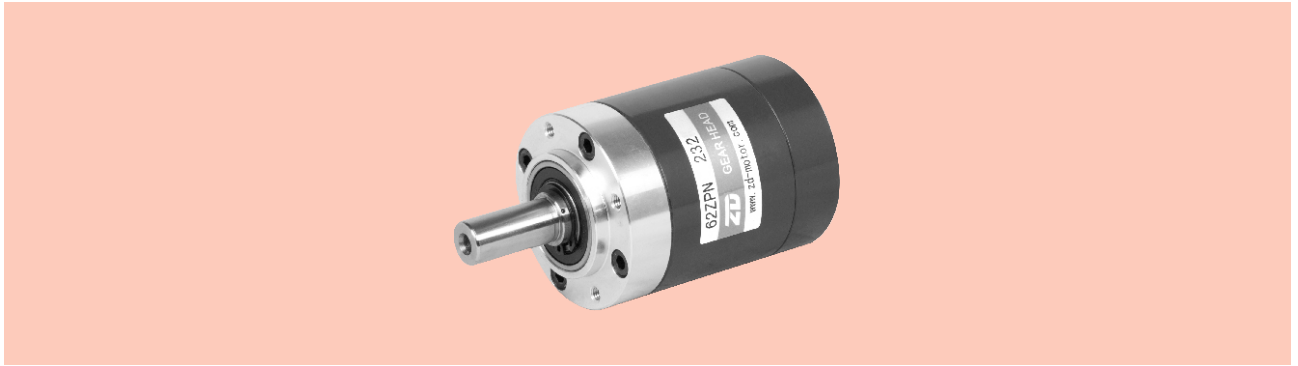

■ 外径62行星减速器 Outdiameter 62mm Planetary Gearbox

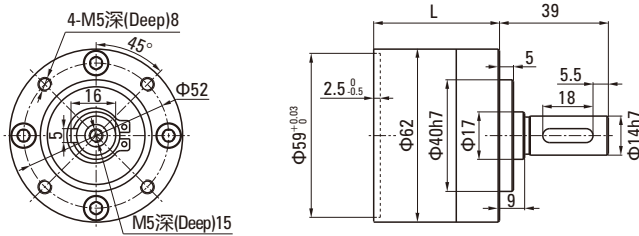

减速箱型号 Gearbox Model	减速比 Gear Ratio	L尺寸(mm) Dimension
62ZPN□	一级Stage1	3.65~8.63
	二级Stage2	14~58
	三级Stage3	67~393

传动级数 Transmission Stage	一级 Stage 1	二级 Stage 2	三级 Stage 3
传动效率 Transmission efficiency	90%	81%	73%
最大径向负载 Max radial load	520N	520N	520N
最大轴向负载 Max axial load	150N	150N	150N
额定扭矩 Rated torque	8N.m	25N.m	50N.m
瞬间承受扭矩 Instant beared torque	2倍与额定扭矩 Two times of the rated torque		
工作温度 Operating temperature	-10°C ~ +80°C		
润滑方式 Lubrication type	终生润滑 Lifetime lubrication		
安装方式 Mounting type	任意安装 Any		
推荐输入转速 Recommend input speed	≤3000RPM		
输入与输出转向 Input and output direction	相同 Same direction		
噪音 Noise	< 60dB(A) (L=1m, 3000rpm)		

电机配合方案 Motor Matching Scheme

Da	一级速比 One stage of gear ratio	二级速比 Second stage of gear ratio	三级速比 Third stage of gear ratio
Φ10.66 ^{+0.05} _{-0.08}	5.36	-	102.88
		-	118.98
Φ8.69 ^{-0.05} _{-0.08}	6.55	28.05	145.36
		33.92	-
Φ6.82 ^{-0.05} _{-0.08}	8.63	44.69	165.64
		58.22	191.56
		-	231.61
		-	301.68
Φ16.11 ^{-0.05} _{-0.08}	3.65	13.53	67.08
		18.92	81.11
		24.65	91.36
		-	127.74

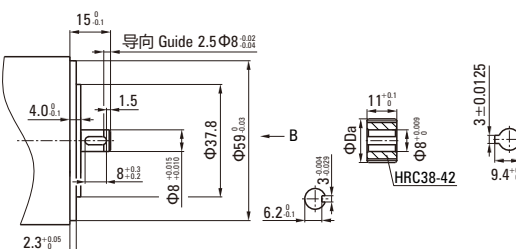
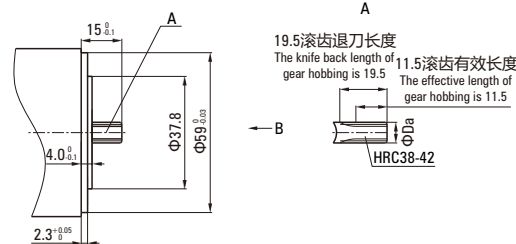
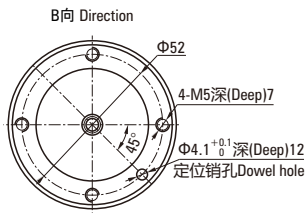

■ ZPNΦ72 BRUSH有刷

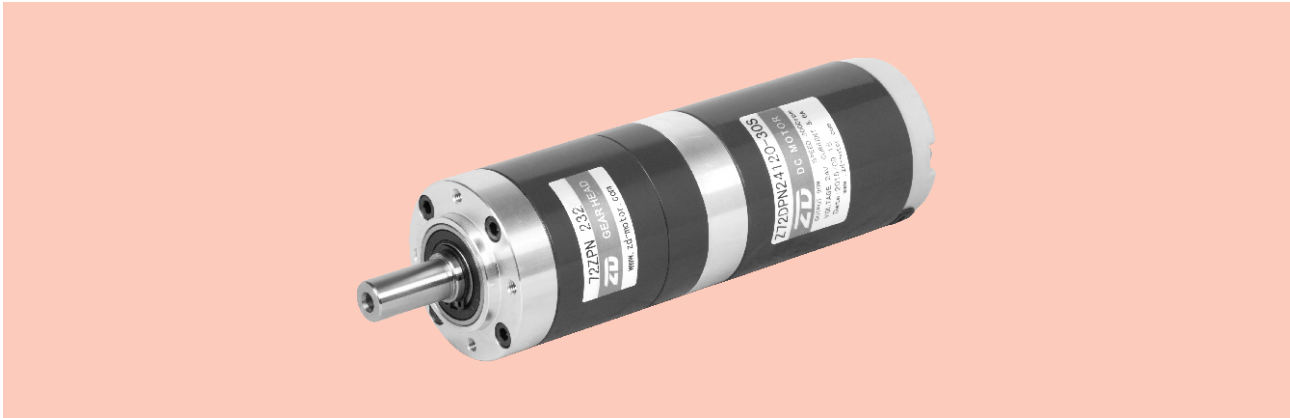

■ 外径72直流有刷行星减速电机外形图纸 Outside Diameter 72 DC Brush Motor

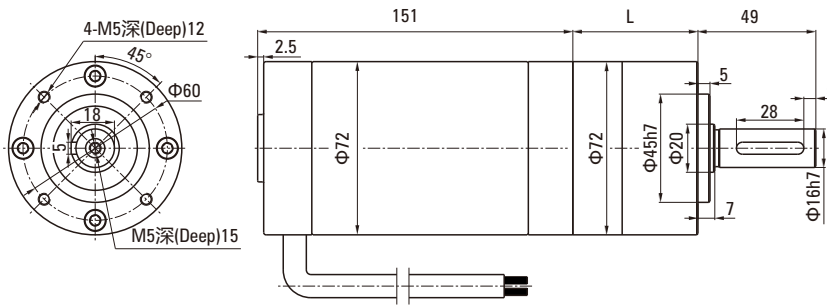

电机型号 Motor Type	减速箱型号 Gearbox Model	减速比 Gear Ratio	L尺寸(mm) Dimension
Z72DPN	72PN□	3.65~8.63	52.00
		13.53~58.22	72.15
		67.08~392.98	92.30

电机接线图 Wiring Diagram

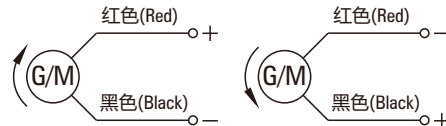

■ 有刷直流电机技术参数 Blush DC Motor Technical Data

电机型号 Motor Type	电压 Voltage V	额定功率 Rated Power W	空载电流 No-load Current A	空载转速 No-load Speed RPM	额定电流 Rated Current A	额定转速 Rated Speed RPM	额定力矩 Rated Torque N.m	电机寿命 Motor Life H
Z72DPN1260-30S	12	60	2.0	3500	7.2	3000	0.191	2000
Z72DPN2490-30S	24	90	2.0	3400	5.5	3000	0.287	2000
Z72DPN24120-30S	24	120	2.0	3500	7.2	3000	0.382	2000

■ 有刷直行星减速电机技术参数 Blush DC Planetary Gear Motor Technical Data-Z72DPN2490-30S

减速比 Ratio	3.65	5.36	6.55	8.63	13.53	18.92	24.65	28.05	33.92	44.69	58.22	67.08	81.11
输出轴转速 r/min Output shaft speed	822	560	458	348	222	159	122	107	89	67	52	45	37
允许力矩 N.m Allowable torque	0.94	1.38	1.69	2.23	3.15	4.40	5.73	6.52	7.89	10.39	13.53	14.05	16.99
减速级数 Reduction stage	1	1	1	1	2	2	2	2	2	2	2	3	3
减速比 Ratio	91.36	102.88	118.98	127.74	145.36	165.64	191.56	231.61	301.68	392.98			
输出轴转速 r/min Output shaft speed	33	29	25	24	21	18	16	13	9.9	7.6			
允许力矩 N.m Allowable torque	19.14	21.55	24.93	26.76	30.45	34.70	40.13	48.52	63.20	82.33			
减速级数 Reduction stage	3	3	3	3	3	3	3	3	3	3			

ZPN系列 ZPN SERIES

■ ZPNΦ72 BRUSHLESS无刷

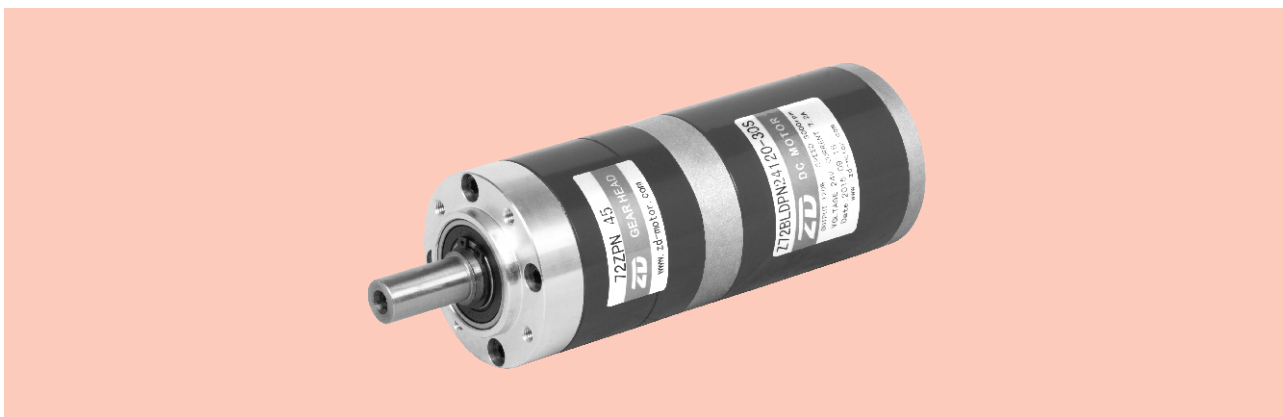

■ 外径72直流无刷行星减速电机外形图纸 Outside Diameter 72 DC Brushless Motor

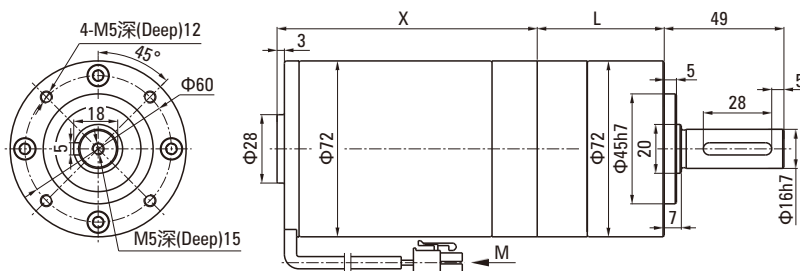

电机型号 Motor Type	X尺寸 (mm) Dimension	减速箱型号 Gearbox Model	减速比 Gear Ratio	L尺寸 (mm) Dimension
Z72BLDPN24120-30S	106.5	72PN□	3.65~8.63	52.0
Z72BLDPN24150-30S	129.5		13.53~58.22	72.15
			67.08~392.98	92.3

M向视图
(View M)

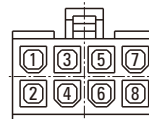

1	2	3	4	5	6	7	8
U	V	W	GND	Hv	Hw	Hu	+Vcc

■ 无刷直流电机技术参数 BLDC Motor Technical Data

电机型号 Motor Type	电压 Voltage V	额定功率 Rated Power W	额定电流 Rated Current A	额定转速 Rated Speed RPM	额定力矩 Rated Torque N.m	防护等级 Grade Protection IP
Z72BLDPN24120-30S	24	120	6.6	3000	0.382	20
Z72BLDPN24150-30S	24	150	8.5	3000	0.478	20

■ 无刷直流行星减速电机技术参数 BLDC Planetary Gear Motor Technical Data-Z72BLDPN24120-30S

减速比 Ratio	3.65	5.36	6.55	8.63	13.53	18.92	24.65	28.05	33.92	44.69	58.22	67.08	81.11
输出轴转速 r/min Output shaft speed	822	560	458	348	222	159	122	107	88	67	52	45	37
允许力矩 N.m Allowable torque	1.25	1.84	2.25	2.97	4.19	5.85	7.63	8.68	10.50	13.83	18.01	18.71	22.62
减速级数 Reduction stage	1	1	1	1	2	2	2	2	2	2	2	3	3

减速比 Ratio	91.36	102.88	118.98	127.74	145.36	165.64	191.56	231.61	301.68	392.98			
输出轴转速 r/min Output shaft speed	33	29	25	23	21	18	16	13	10	8			
允许力矩 N.m Allowable torque	25.48	28.69	33.18	35.62	40.50	46.19	53.42	64.59	84.00	84.00			
减速级数 Reduction stage	3	3	3	3	3	3	3	3	3	3			

■ ZPNΦ72

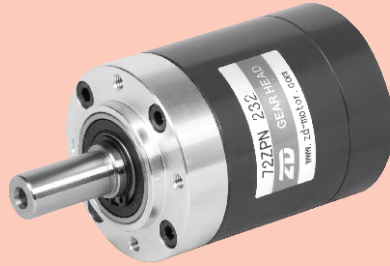

■ 外径72行星减速器 Outdiameter 72mm Planetary Gearbox

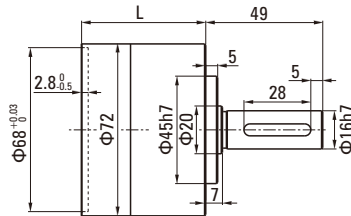
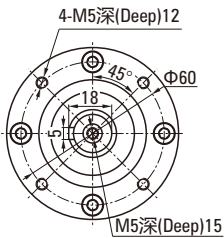

减速箱型号 Gearbox Model	减速比 Gear Ratio	L尺寸(mm) Dimension
72ZPN□	一级Stage1	3.65~8.63
	二级Stage2	14~58
	三级Stage3	67~393

传动级数 Transmission Stage	一级 Stage 1	二级 Stage 2	三级 Stage 3
传动效率 Transmission efficiency	90%	81%	73%
最大径向负载 Max radial load	760N	760N	760N
最大轴向负载 Max axial load	160N	160N	160N
额定扭矩 Rated torque	14N.m	42N.m	84N.m
瞬间承受扭矩 Instant beared torque	2倍与额定扭矩 Two times of the rated torque		
工作温度 Operating temperature	-10°C ~ +80°C		
润滑方式 Lubrication type	终生润滑 Lifetime lubrication		
安装方式 Mounting type	任意安装 Any		
推荐输入转速 Recommend input speed	≤3000RPM		
输入与输出转向 Input and output direction	相同 Same direction		
噪音 Noise	< 60dB(A) (L=1m, 3000rpm)		

电机配合方案 Motor Matching Scheme

	Da	一级速比 One stage of gear ratio	二级速比 Second stage of gear ratio	三级速比 Third stage of gear ratio
	Φ12.47 ^{+0.05} _{-0.08}	5.36	-	102.88
	Φ10.27 ^{+0.05} _{-0.08}	6.55	28.05	145.36
	Φ7.99 ^{+0.05} _{-0.08}	8.63	44.69	165.64
			58.22	191.56
			-	231.61
			-	301.68
			-	392.98
	Φ18.68 ^{+0.05} _{-0.08}	3.65	13.53	67.08
			18.92	81.11
			24.65	91.36
			-	127.74

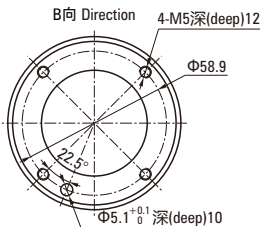

ZPN系列 ZPN SERIES

■ ZPNΦ82 BRUSH有刷

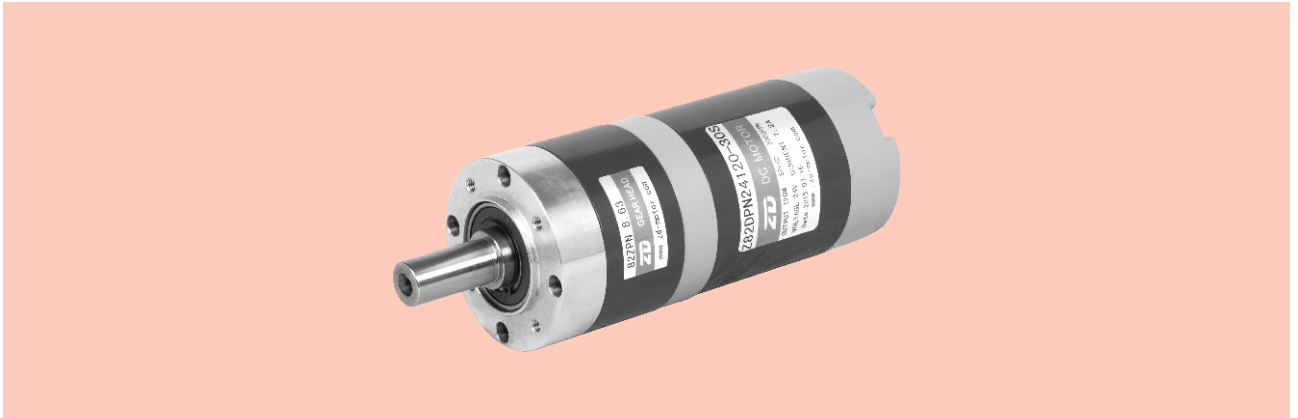

■ 外径82直流有刷行星减速电机外形图纸 Outside Diameter 82 DC Brush Motor

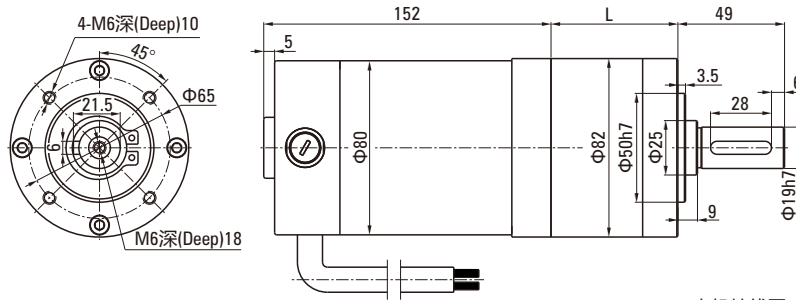

电机型号 Motor Type	减速箱型号 Gearbox Model	减速比 Gear Ratio	L尺寸(mm) Dimension
Z82DPN	82PN□	3.65~8.63	63.70
		13.53~58.22	80.50
		67.08~392.98	103.2

电机接线图 Wiring Diagram

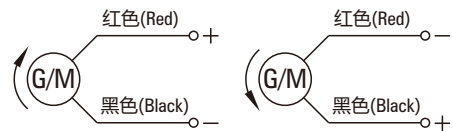

■ 有刷直流电机技术参数 Blush DC Motor Technical Data

电机型号 Motor Type	电压 Voltage V	额定功率 Rated Power W	空载电流 No-load Current A	空载转速 No-load Speed RPM	额定电流 Rated Current A	额定转速 Rated Speed RPM	额定力矩 Rated Torque N.m	电机寿命 Motor Life H
Z82DPN1290-30S	12	90	2.5	3500	10.5	3000	0.287	2000
Z82DPN24120-30S	24	120	2.0	3400	7.20	3000	0.382	2000
Z82DPN48180-30S	48	180	1.5	3400	5.50	3000	0.573	2000

■ 有刷直流行星减速电机技术参数 Blush DC Planetary Gear Motor Technical Data-Z82DPN24120-30S

减速比 Ratio	3.65	5.36	6.55	8.63	13.53	18.92	24.65	28.05	33.92	44.69	58.22	67.08	81.11
输出轴转速 r/min Output shaft speed	822	560	458	348	222	159	122	107	89	67	52	45	37
允许力矩 N.m Allowable torque	1.30	1.80	2.30	3.00	4.20	5.90	7.60	8.70	10.5	13.8	18.0	18.7	22.6
减速级数 Reduction stage	1	1	1	1	2	2	2	2	2	2	2	3	3

减速比 Ratio	91.36	102.88	118.98	127.74	145.36	165.64	191.56	231.61	301.68	392.98			
输出轴转速 r/min Output shaft speed	33	29	25	24	21	18	16	13	9.9	7.6			
允许力矩 N.m Allowable torque	25.5	28.7	33.2	35.6	40.5	46.2	53.4	64.6	84.0	84.0			
减速级数 Reduction stage	3	3	3	3	3	3	3	3	3	3			

■ ZPNΦ82 BRUSHLESS无刷

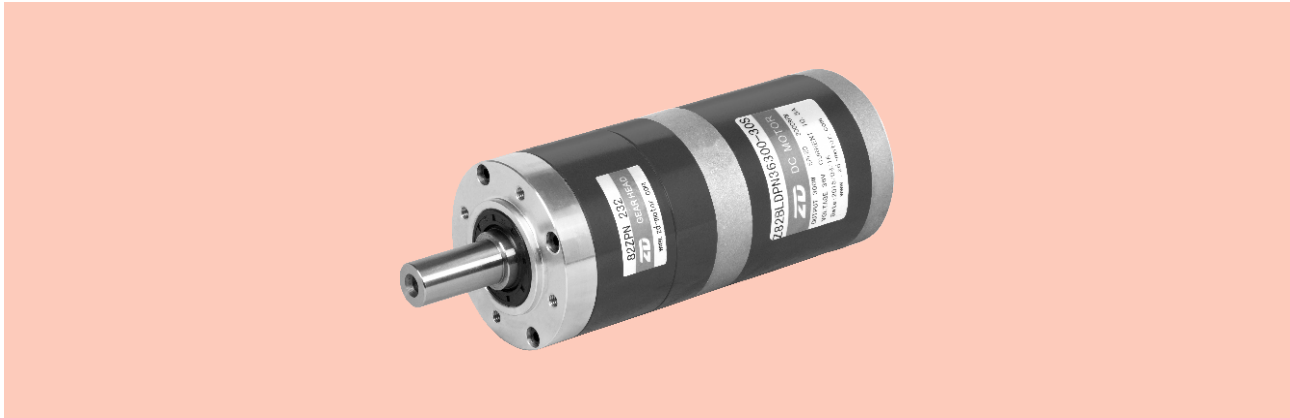

■ 外径82直流无刷行星减速电机外形图纸 Outside Diameter 82 DC Brushless Motor

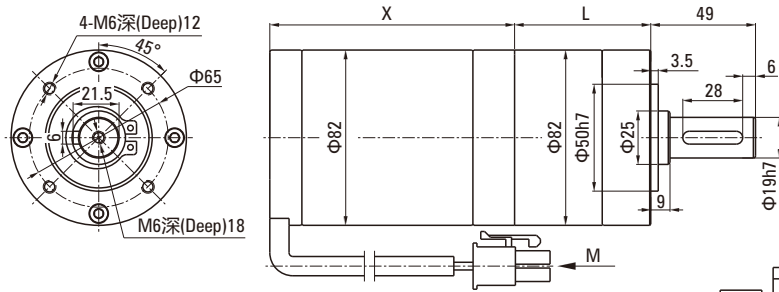

电机型号 Motor Type	X尺寸 (mm) Dimension	减速箱型号 Gearbox Model	减速比 Gear Ratio	L尺寸 (mm) Dimension
Z82BLDPN24200-30S	114.5	82PN□	3.65~8.63	63.70
Z82BLDPN24300-30S	136.5		13.53~58.22	80.50
			67.08~392.98	103.2

M向视图
(View M)

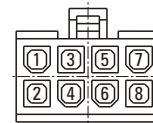

1	2	3	4	5	6	7	8
U	V	W	GND	Hv	Hw	Hu	+Vcc

■ 无刷直流电机技术参数 BLDC Motor Technical Data

电机型号 Motor Type	电压 Voltage V	额定功率 Rated Power W	额定电流 Rated Current A	额定转速 Rated Speed RPM	额定力矩 Rated Torque N.m	防护等级 Grade Protection IP
Z82BLDPN24200-30S	24	200	12	3000	0.637	20
Z82BLDPN24300-30S	24	300	18	3000	0.955	20

■ 无刷直流行星减速电机技术参数 BLDC Planetary Gear Motor Technical Data-Z82BLDPN24200-30S

减速比 Ratio	3.65	5.36	6.55	8.63	13.53	18.92	24.65	28.05	33.92	44.69	58.22	67.08	81.11
输出轴转速 r/min Output shaft speed	822	560	458	348	222	159	122	107	88	67	52	45	37
允许力矩 N.m Allowable torque	2.09	3.07	3.75	4.94	6.98	9.76	12.71	14.47	17.49	23.05	30.02	31.18	37.70
减速级数 Reduction stage	1	1	1	1	2	2	2	2	2	2	2	3	3
减速比 Ratio	91.36	102.88	118.98	127.74	145.36	165.64	191.56	231.61	301.68	392.98			
输出轴转速 r/min Output shaft speed	33	29	25	23	21	18	16	13	10	8			
允许力矩 N.m Allowable torque	42.46	47.82	55.30	59.37	67.56	76.98	89.03	107.64	120.0	120.0			
减速级数 Reduction stage	3	3	3	3	3	3	3	3	3	3			

ZPN系列 ZPN SERIES

■ ZPNΦ82

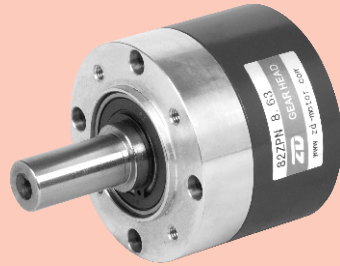

■ 外径82行星减速器 Outdiameter 82mm Planetary Gearbox

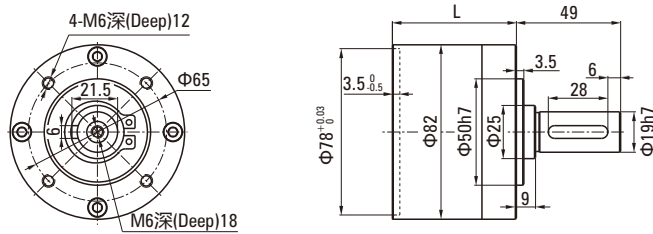

减速箱型号 Gearbox Model	减速比 Gear Ratio	L尺寸(mm) Dimension
82ZPN□	一级Stage1	3.65~8.63
	二级Stage2	14~58
	三级Stage3	67~393

传动级数 Transmission Stage	一级 Stage 1	二级 Stage 2	三级 Stage 3
传动效率 Transmission efficiency	90%	81%	73%
最大径向负载 Max radial load	1000N	1000N	1000N
最大轴向负载 Max axial load	200N	200N	200N
额定扭矩 Rated torque	20N.m	60N.m	120N.m
瞬间承受扭矩 Instant beared torque	2倍与额定扭矩 Two times of the rated torque		
工作温度 Operating temperature	-10°C ~ +80°C		
润滑方式 Lubrication type	终生润滑 Lifetime lubrication		
安装方式 Mounting type	任意安装 Any		
推荐输入转速 Recommend input speed	≤3000RPM		
输入与输出转向 Input and output direction	相同 Same direction		
噪音 Noise	< 60dB(A) (L=1m, 3000rpm)		

电机配合方案 Motor Matching Scheme

	Da	一级速比 One stage of gear ratio	二级速比 Second stage of gear ratio	三级速比 Third stage of gear ratio
<p>23滚齿退刀长度 The knife back length of gear hobbing is 23 14.5滚齿有效长度 The effective length of gear hobbing is 14.5 HRC38-42</p>	Φ14.25 ^{+0.05} _{-0.08}	5.36	-	102.88
	Φ11.55 ^{+0.05} _{-0.08}	6.55	28.05	145.36
	Φ9.12 ^{+0.05} _{-0.08}	8.63	44.69	165.64
<p>导向 Guide 2.5 Φ10^{+0.02}</p>	Φ21.45 ^{+0.05} _{-0.08}	3.65	13.53	67.08
			18.92	81.11
			24.65	91.36
			-	127.74

■ ZPNΦ105 BRUSH有刷

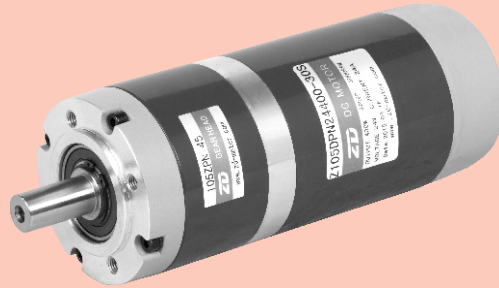

■ 外径105直流有刷行星减速电机外形图纸 Outside Diameter 105 DC Brush Motor

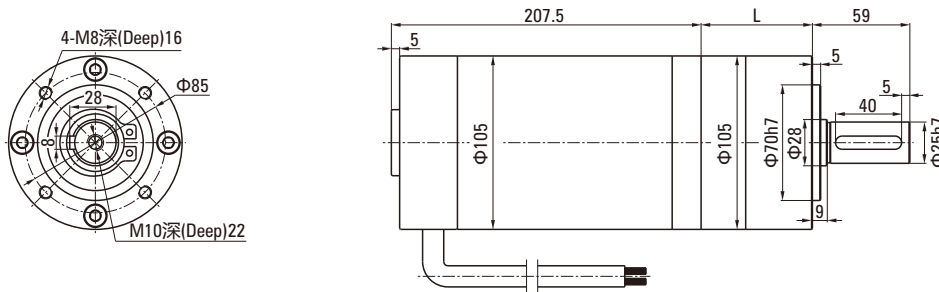

电机型号 Motor Type	减速箱型号 Gearbox Model	减速比 Gear Ratio	L尺寸(mm) Dimension
Z105DPN	105ZPN□	一级Stage1 3.65~8.63	83.80
		二级Stage2 14~58	114.9
		三级Stage3 67~393	146.0

电机接线图 Wiring Diagram

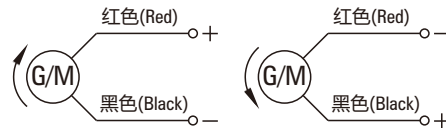

■ 有刷直流电机技术参数 Blush DC Motor Technical Data

电机型号 Motor Type	电压 Voltage V	功率 Power W	空载电流 No-load Current A	空载转速 No-load Speed RPM	额定电流 Rated Current A	额定转速 Rated Speed RPM	额定力矩 Rated Torque N.m	电机寿命 Motor Life H
Z105DPN12200-30S	12	200	3.5	3500	24	3000	0.637	2000
Z105DPN24400-30S	24	400	2.5	3500	24	3000	1.273	2000
Z105DPN48600-30S	48	600	2.5	3500	17	3000	1.910	2000

■ 有刷直流行星减速电机技术参数 Blush DC Planetary Gear Motor Technical Data-Z105DPN24400-30S

减速比 Ratio	3.65	5.36	6.55	8.63	13.53	18.92	24.65	28.05	33.92	44.69	58.22	67.08	81.11
输出轴转速 r/min Output shaft speed	822	560	458	348	222	159	122	107	88	67	52	45	37
允许力矩 N.m Allowable torque	4.18	6.14	7.51	9.89	13.95	19.51	25.42	28.93	34.99	46.09	60.05	62.35	75.39
减速级数 Reduction stage	1	1	1	1	2	2	2	2	2	2	2	3	3

减速比 Ratio	91.36	102.88	118.98	127.74	145.36	165.64	191.56	231.61	301.68	392.98			
输出轴转速 r/min Output shaft speed	33	29	25	23	21	18	16	13	10	8			
允许力矩 N.m Allowable torque	84.92	95.63	110.60	118.74	135.12	153.97	178.06	195.00	195.00	195.00			
减速级数 Reduction stage	3	3	3	3	3	3	3	3	3	3			

ZPN系列 ZPN SERIES

■ ZPNΦ105 BRUSHLESS无刷

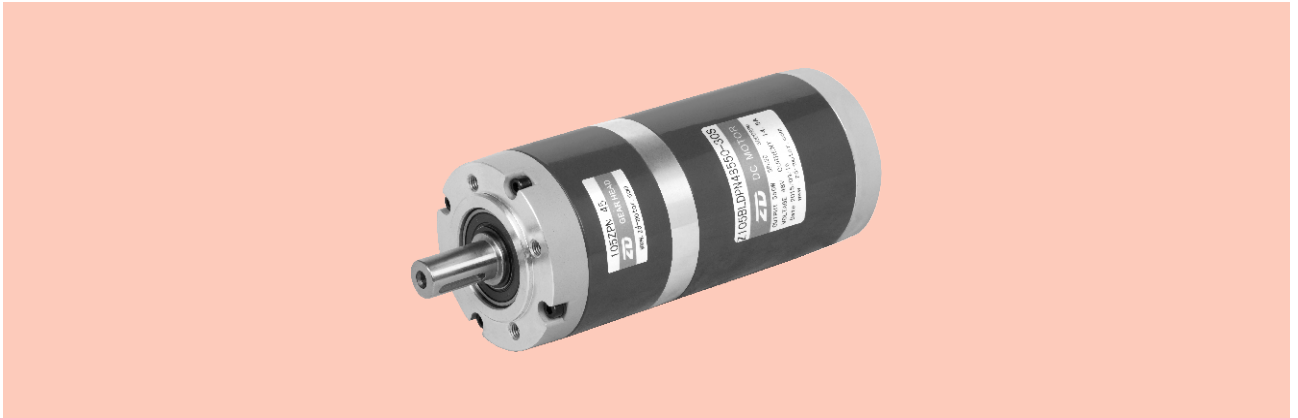

■ 外径105直流无刷行星减速电机外形图纸 Outside Diameter 105 DC Brushless Motor

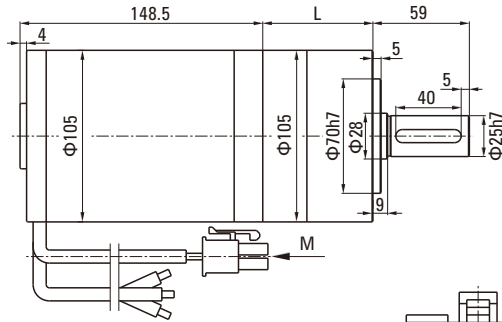
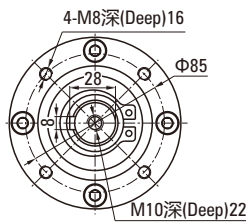

M向视图
(View M)

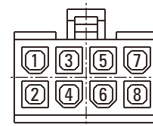

电机型号 Motor Type	减速箱型号 Gearbox Model	减速比 Gear Ratio		L尺寸(mm) Dimension
Z105BLDPN	105ZPN□	一级Stage1	3.65~8.63	83.80
		二级Stage2	14~58	114.9
		三级Stage3	67~393	146.0

1	2	3	4	5	6	7	8
			GND	Hv	Hw	Hu	+Vcc

■ 无刷直流电机技术参数 BLDC Motor Technical Data

电机型号 Motor Type	电压 Voltage V	功率 Power W	空载电流 No-load Current A	空载转速 No-load Speed RPM	额定电流 Rated Current A	额定转速 Rated Speed RPM	额定力矩 Rated Torque N.m	电机寿命 Motor Life H
Z105BLDPN24350-30S	24	350	1.8	3500	18.5	3000	1.114	5000
Z105BLDPN48550-30S	48	550	1.5	3500	14.5	3000	1.751	5000
Z105BLDPN48750-30S	48	750	1.8	3600	19.5	3000	2.386	5000

■ 无刷直行星减速电机技术参数 BLDC Planetary Gear Motor Technical Data-Z105BLDPN48550-30S

减速比 Ratio	3.65	5.36	6.55	8.63	13.53	18.92	24.65	28.05	33.92	44.69	58.22	67.08	81.11
输出轴转速 r/min Output shaft speed	822	560	458	348	222	159	122	107	89	67	52	45	37
允许力矩 N.m Allowable torque	5.75	8.45	10.32	13.60	19.19	26.83	34.96	39.78	48.10	63.38	82.57	85.74	103.67
减速级数 Reduction stage	1	1	1	1	2	2	2	2	2	2	2	3	3

减速比 Ratio	91.36	102.88	118.98	127.74	145.36	165.64	191.56	231.61	301.68	392.98			
输出轴转速 r/min Output shaft speed	33	29	25	24	21	18	16	13	9.9	7.6			
允许力矩 N.m Allowable torque	116.77	131.49	152.07	163.27	185.79	195.00	195.00	195.00	195.00	195.00			
减速级数 Reduction stage	3	3	3	3	3	3	3	3	3	3			

■ ZPNΦ120 BRUSH有刷

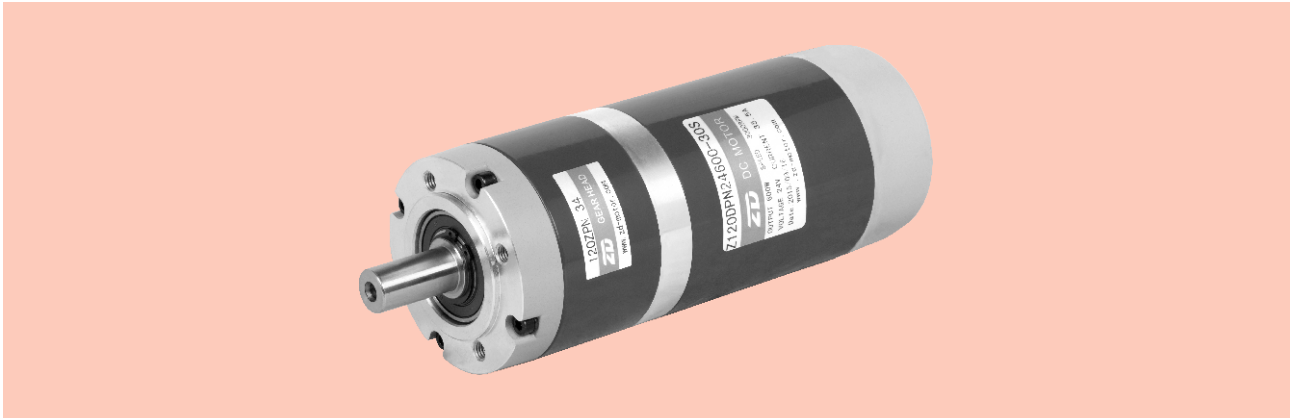

■ 外径120直流有刷行星减速电机外形图纸 Outside Diameter 120 DC Brush Motor

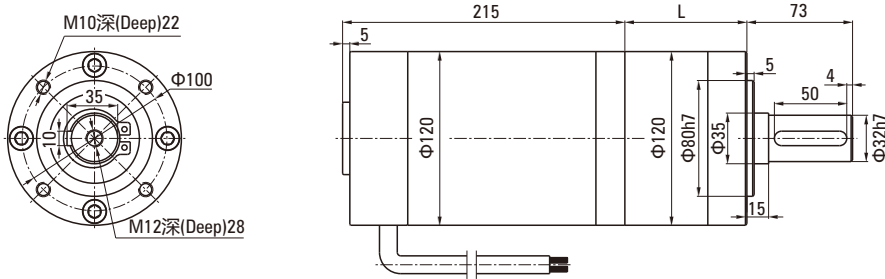

电机型号 Motor Type	减速箱型号 Gearbox Model	减速比 Gear Ratio	L尺寸(mm) Dimension
Z120DPN	120ZPN□	一级Stage1 3.65~8.63	92.00
		二级Stage2 14~58	127.0
		三级Stage3 67~393	162.0

电机接线图 Wiring Diagram

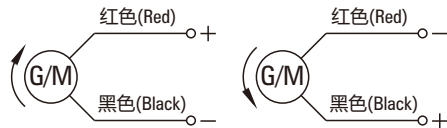

■ 有刷直流电机技术参数 Blush DC Motor Technical Data

电机型号 Motor Type	电压 Voltage V	功率 Power W	空载电流 No-load Current A	空载转速 No-load Speed RPM	额定电流 Rated Current A	额定转速 Rated Speed RPM	额定力矩 Rated Torque N.m	电机寿命 Motor Life H
Z120DPN12300-30S	12	300	4.0	3500	35.5	3000	0.955	2000
Z120DPN24600-30S	24	600	3.0	3500	35.5	3000	1.910	2000
Z120DPN48750-30S	48	750	2.5	3700	21.0	3000	2.388	2000

■ 有刷直流行星减速电机技术参数 Blush DC Planetary Gear Motor Technical Data-Z120DPN24600-30S

减速比 Ratio	3.65	5.36	6.55	8.63	13.53	18.92	24.65	28.05	33.92	44.69	58.22	67.08	81.11
输出轴转速 r/min Output shaft speed	822	560	458	348	222	159	122	107	88	67	52	45	37
允许力矩 N.m Allowable torque	6.27	9.21	11.26	14.83	20.93	29.27	38.14	43.40	52.48	69.14	90.07	93.53	113.09
减速级数 Reduction stage	1	1	1	1	2	2	2	2	2	2	2	3	3
减速比 Ratio	91.36	102.88	118.98	127.74	145.36	165.64	191.56	231.61	301.68	392.98			
输出轴转速 r/min Output shaft speed	33	29	25	23	21	18	16	13	10	8			
允许力矩 N.m Allowable torque	127.38	143.45	165.89	178.11	202.68	230.95	267.09	300.00	300.00	300.00			
减速级数 Reduction stage	3	3	3	3	3	3	3	3	3	3			

ZPN系列 ZPN SERIES

■ ZPNΦ120 BRUSHLESS无刷

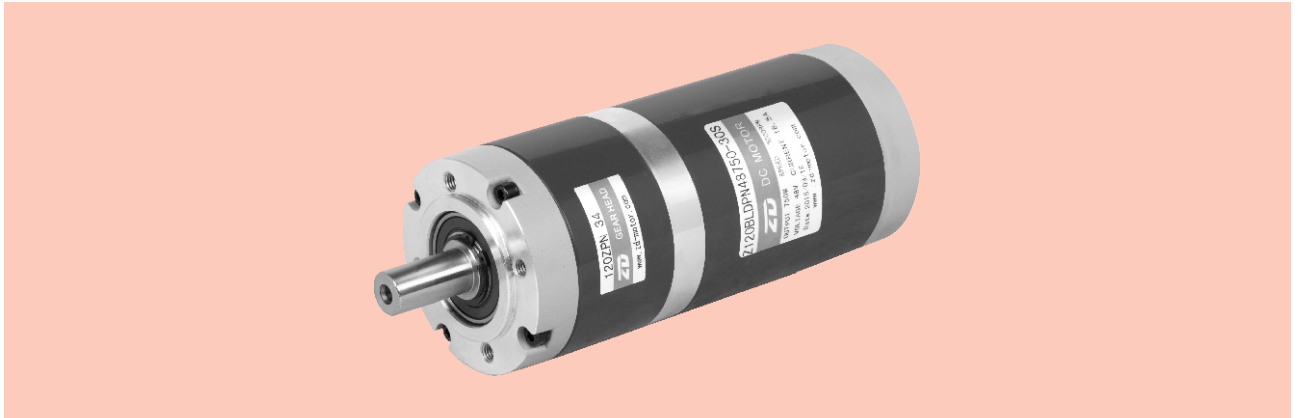

■ 外径120直流无刷行星减速电机外形图纸 Outside Diameter 120 DC Brushless Motor

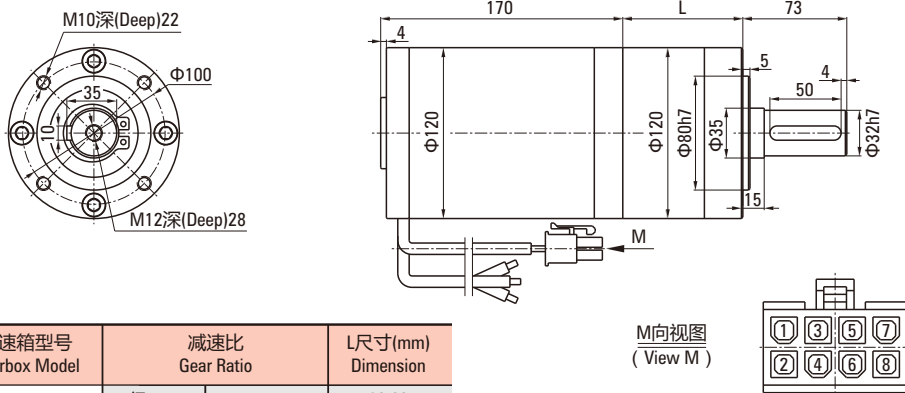

电机型号 Motor Type	减速箱型号 Gearbox Model	减速比 Gear Ratio		L尺寸(mm) Dimension
Z120BLDPN	120ZPN□	一级Stage1	3.65~8.63	92.00
		二级Stage2	14~58	127.0
		三级Stage3	67~393	162.0

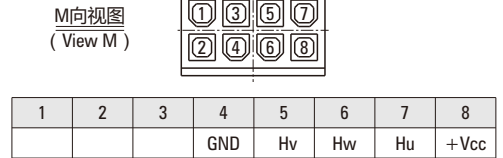

■ 无刷直流电机技术参数 BLDC Motor Technical Data

电机型号 Motor Type	电压 Voltage V	功率 Power W	空载电流 No-load Current A	空载转速 No-load Speed RPM	额定电流 Rated Current A	额定转速 Rated Speed RPM	额定力矩 Rated Torque N.m	电机寿命 Motor Life H
Z120BLDPN24400-30S	24	400	3.0	3500	20.5	3000	1.273	5000
Z120BLDPN48750-30S	48	750	2.5	3600	18.5	3000	2.388	5000
Z120BLDPN48900-30S	48	900	2.5	3700	23.5	3000	2.865	5000

■ 无刷直行星减速电机技术参数 BLDC Planetary Gear Motor Technical Data-Z120BLDPN48750-30S

减速比 Ratio	3.65	5.36	6.55	8.63	13.53	18.92	24.65	28.05	33.92	44.69	58.22	67.08	81.11
输出轴转速 r/min Output shaft speed	822	560	458	348	222	159	122	107	89	67	52	45	37
允许力矩 N.m Allowable torque	7.84	11.52	14.07	18.54	26.17	36.59	47.67	54.25	65.60	86.42	112.59	116.91	141.36
减速级数 Reduction stage	1	1	1	1	2	2	2	2	2	2	2	3	3

减速比 Ratio	91.36	102.88	118.98	127.74	145.36	165.64	191.56	231.61	301.68	392.98			
输出轴转速 r/min Output shaft speed	33	29	25	24	21	18	16	13	9.9	7.6			
允许力矩 N.m Allowable torque	159.23	179.31	207.37	222.63	253.34	288.69	300.00	300.00	300.00	300.00			
减速级数 Reduction stage	3	3	3	3	3	3	3	3	3	3			

控制器 CONTROLLER

■ 控制器 Contoller

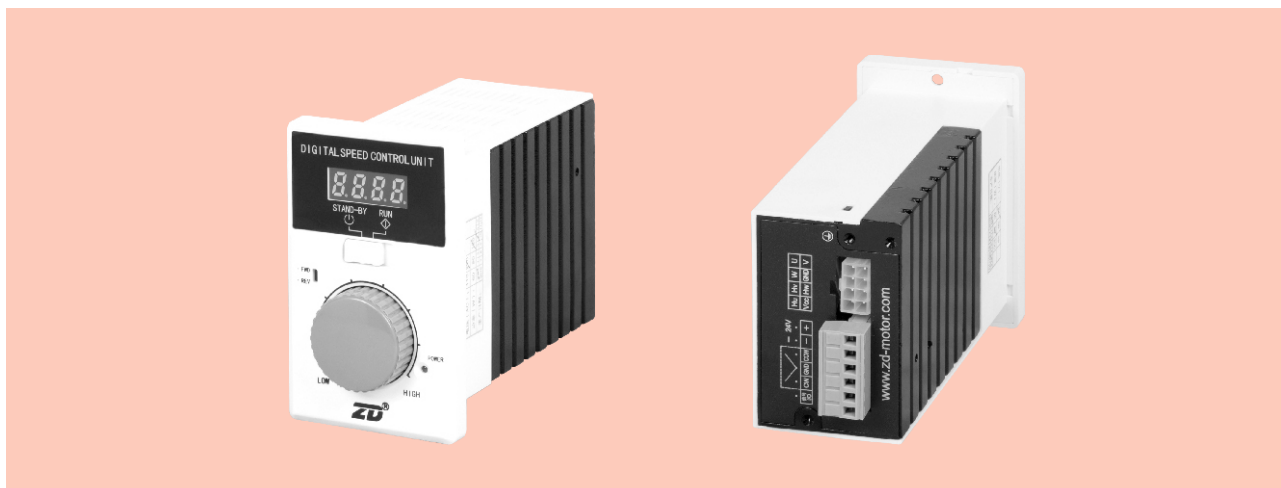

■ 控制器外形图纸 Drive Drawip Of Contoller

Z BLD.CON - 220 A 10 - V1
 ① ② ③ ④ ⑤ ⑥

电机参数 Motor Parameters	①	Z:	ZD中大电机
	②	BLD.CON:	直流无刷驱动器 BLDC Driver
	③	电压 Voltage:	220V
	④	A:	AC无A时, DC DC: Without A
	⑤	功率 Power:	10W
	⑥	V1:	驱动器特性 Feature of driver

■ 特点 Characteristic

- 采用新型高压功率模块控制技术，功能齐全，性能优越。
- 采用霍尔信号进行速度闭环控制，系统控制稳定可靠。
- 采用数字显示转速及报警提示，简洁直观。
- 可实现启动加速度快慢调整，加速度时间0.1~1秒可调，出厂值。
- 为0.5秒/P可面板操作、外接开关操作或485通讯操作。
- 保护功能齐全、保护动作灵敏可靠。
- Adopt new high voltage power module control technology, complete functions, superior performance.
- Holzer signal is used to speed closed-loop control, the system is stable and reliable-digital display speed and alarm prompt, simple and intuitive.
- Can achieve the start of the acceleration speed adjustment, acceleration time 0.1~1.
- Seconds adjustable, the factory value.
- For 0.5 seconds/P can be panel operation, external switch operation or 485 communication operation.
- Protection, protection of the action is sensitive and reliable.

■ 注意事项 Note

- 此驱动器尺寸适用于本册样本上所有无刷电机。
- 通电使用前必须保证驱动器及电机接地线接地良好。
- 驱动器应置于散热性能好，外在干扰小的工作场所。
- 驱动器使用环境温度-10°C~+10°C。
- 驱动器防护等级IP00，不得工作于有铁质等导体碎屑、潮湿等不良存在的场所；空气相对湿度不大于80%，无结冰及凝露。
- The drive size is applicable to all non brush motor on the sample.
- Must ensure that the drive and the motor grounding wire is good before the power use.
- Drivers should be placed in the work place with good heat dissipation performance and small external interference.
- Drive the use of ambient temperature -10°C~+10°C.
- And drive level of protection IP00, may not work in iron and other debris conductor, damp and adverse existing places; air relative humidity is not more than 80%, and no freezing and condensation.

控制器 CONTROLLER

整体尺寸 Overall Size

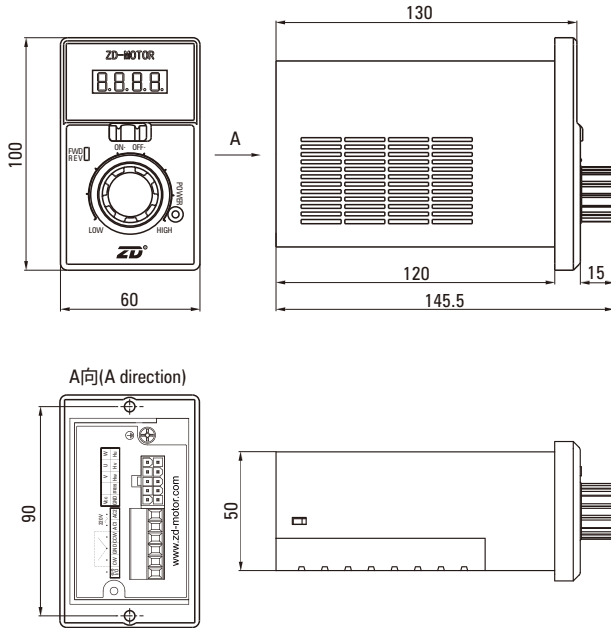

面板说明 Notes

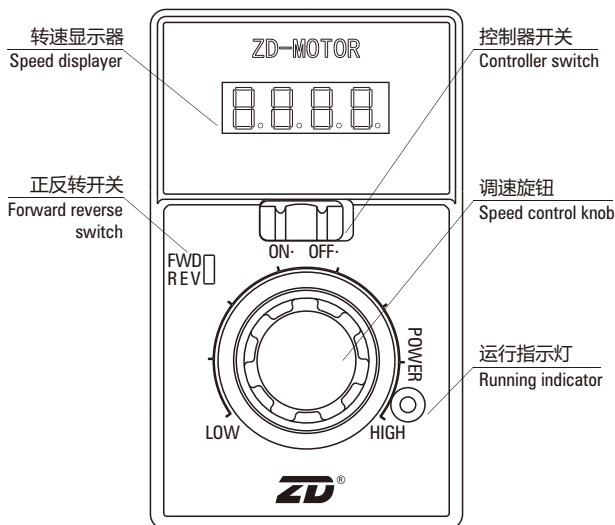

安装固定 Fixed Installation

1. 打开面板 ③。 Open panel ③.
2. 将驱动器本体 ① 插入固定位置。 Insert drive body ① in a fixed position.
3. 用M4沉头螺钉(GB68-85) ② 固定连接。 M4 head screw (GB68-85) ② fixed connection.
4. 将面板 ③ 压扣到位如示意图。 Place the panel ③ button in place as a schematic diagram.

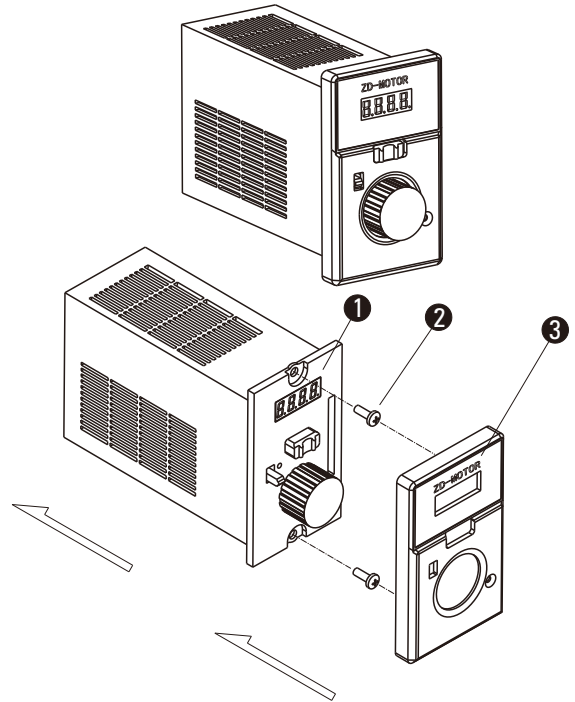

注意 Note :

- 如果电机方向为尾部控制，则面板无正反方向开关。
- 正反转开关只适用于调试时正反转切换，不适用于工作过程中频繁切换，有频繁切换时用尾部控制模式。
- If the direction of the motor is the tail control, the panel has no positive or negative direction.
- The reverse switch is only suitable for the adjustment of the positive and negative switch, and is not suitable for frequent switching in the work process, the use of the tail control module when frequent switching type.

接线端口说明 Connection Port Description

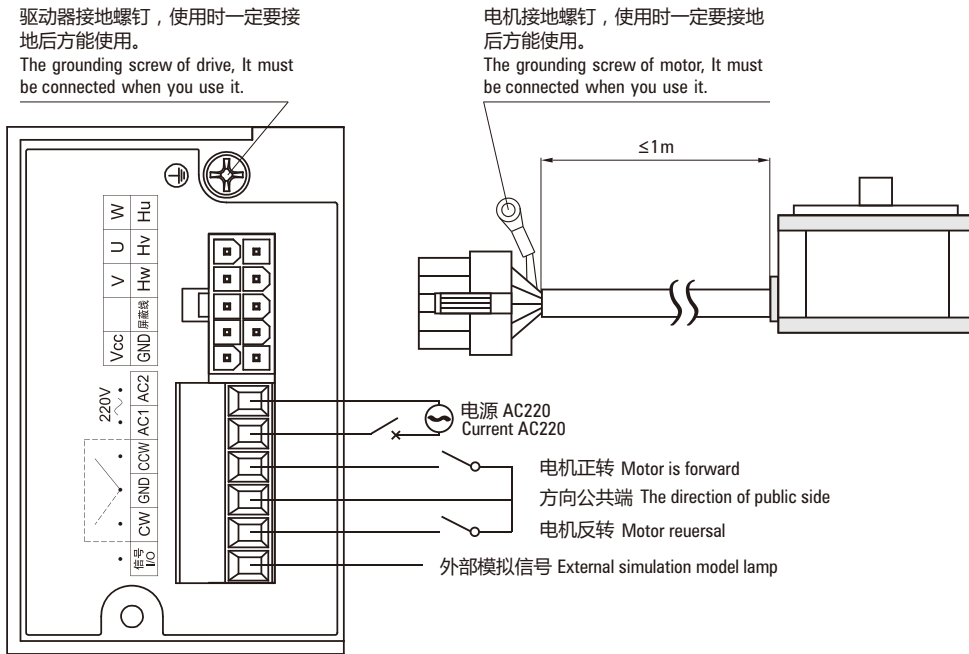

注意Note :

- 如果电机方向需远程控制，则需通过继电器或485通讯控制方向切换。
- 通电使用前必须保证驱动器及电机接地线接地良好。
- If the direction of the motor needs to be controlled remotely, it is necessary to control the direction of the relay or 485 communication.
- Must ensure that the drive and the motor grounding wire is good before the power use.

电源、控制端 Power Supply, Control Terminal

引角名 Lead Angle	中文定义 Definition Of Chinese
AC1	交流220V火线 AC 220V live wire
AC2	交流220V零线 AC 220V zero line
信号 Signal I/O	外部模拟信号 External analog signal
CW	电机正转 Motor forward
GND	方向公共端 Direction common
GND	电机反转 Motor reverse

电机连接端 Motor Connecting End

引角名 Lead Angle	中文定义 Definition Of Chinese	颜色 Colour
U	电机U相 Motor U phase	灰(黄) Ash (yellow)
V	电机V相 Motor V phase	粉(绿) Powder (green)
W	电机W相 Motor W phase	蓝(蓝) Blue (blue)
Hu	霍尔信号U相输入端 Holzer signal U phase input	黄(黄) Yellow (yellow)
Hv	霍尔信号V相输入端 Holzer signal V phase input	绿(绿) Green (green)
Hw	霍尔信号W相输入端 Holzer signal W phase input	棕(蓝) Brown (blue)
Vcc	霍尔信号电源线 Holzer signal power line	红(红) Red (red)
GND	霍尔信号地线 Holzer signal ground	白(黑) White (black)
屏蔽线 Shielding wire	信号屏蔽线 Signal shielding line	银(银) Silver (silver)

控制器 CONTROLLER

故障报警 Fault Alarm

- 驱动器内部出现电流过流、温度过高或其他异常时，会进入保护状态，停止工作。同时数码管闪烁并且显示故障类型。
- 在断电情况下，根据故障类型参照故障事项说明，检查相应问题，排除故障重新上电，解除报警。
- When the internal flow, temperature, or other abnormalities occur in the drive, it will enter the protection status and stop working. At the same time, digital tube flashing and display the type of failure.
- In the case of power failure, according to the fault type of reference to the failure of the matter, to check the corresponding problem, troubleshooting the fault on the power to lift the alarm.

故障事项 Trouble

故障显示 Fault Display	故障内容 Fault Content	解决方案 Solution
ERR 1	短路异常 Short-circuit anomaly	检查驱动器、电机线是否短路 Check whether the drive, motor line is short circuit
ERR 2	霍尔异常 Holzer anomaly	检查电机连接端接触是否良好 Check motor connection end contact is good
ERR 3	电流异常 Current anomaly	检查电机是否堵转、超出额定负载 Check if the motor is locked up, beyond the rated load
ERR 4	电压异常 Voltage abnormality	检查输入电压是否正常 Check whether the input voltage is normal
ERR 5	方向异常 Direction anomaly	检查电机方向信号是否同时短路 Check motor direction signal is short circuit
ERR 6	过热保护 Overheat protection	检查驱动器散热环境是否良好 Check whether the drive cooling environment is good
ERR 7	系统异常 Abnormal system	内部系统出错 Internal system error

▲ 检查、排除故障时务必切断输入交流总电源，然后重新上电，如仍有故障存在，请联系我们。
To check and eliminate the fault, we must cut off the total power supply, and then re power, if there is still a failure, please contact us.

注意事项 Notes

- 正确插接好电机引线，外接电源线并保证电机和驱动器接地线良好可靠。
- 打开电源开关，电源指示灯亮。
- 选择电机运行方向。
- 调整电位器旋钮位置至所需要转速，速电位器旋钮顺时针旋为速度增加。
- Right, well spliced lead wire of the motor, the external power line and ensure the motor and drive ground is good and reliable.
- Open the power switch, the power indicator light.
- Selection of motor running direction.
- Adjust the potentiometer knob to the desired speed, the speed potentiometer knob clockwise rotation to increase.

CATALOGUE



精密谐波齿轮减速器
PRECISION STRAIN WAVE GEAR REDUCER

ZD 中大力德



摆线针轮精密减速器
CYCLOIDAL PIN WHEEL PRECISION REDUCER

ZD 中大力德



微型永磁无刷齿轮减速电机
DC BRUSHLESS GEAR MOTOR

ZD 中大力德



ZB/ZBR/ZE/ZER/HD/HDR系列
高精度行星减速机
PLANETARY GEAR BOX

ZD 中大力德



ZDE/ZDF/ZDWE/ZDWF/ZDS系列
高精度行星减速机
PLANETARY GEAR BOX

ZD 中大力德



伺服驱动器 / 无刷驱动器
工业车辆驱动器 / 交流调速器
SERVO DRIVER / BRUSHLESS DRIVER
INDUSTRIAL VEHICLE DRIVER / AC SPEED CONTROLLER

ZD 中大力德

TRANSMISSION PLANETARY GEAR MOTOR CATALOGUE

宁波中大力德智能传动股份有限公司
NINGBO ZHONGDA LEADER INTELLIGENT TRANSMISSION CO.,LTD.
地址：浙江省慈溪高新技术产业开发区新兴一路185号
Add: NO.185 1st xinxing road, new industrial zone, cixi city, zhejiang, china.

宁波中大创远精密传动设备有限公司
ZHONGDA CHUANGYUAN PRECISE TRANSMISSION EQUIPMENT CO.,LTD.
地址：浙江省慈溪市杭州湾新区金慈路159号
Add: No.159 jinci road, hangzhou bay district, cixi city, zhejiang, china.

国内贸易服务：
电话：86-574-63537377
传真：86-574-63534879
E-mail: china@zd-motor.com

国际贸易服务：
International trade department:
Tel: 86-574-63537171 Fax: 86-574-63534879
E-mail: sales@zd-motor.com
Web: www.zddriver.com
www.zd-motor.com

更多详情，敬请浏览：
www.zd-motor.com